

540-100-1**CNC-Doppelsteppstich-Knopflochautomat
CNC double lockstitch buttonholer**Bedienanleitung / [Operating Instructions](#)

Aufstellanleitung / Installation Instructions

Serviceanleitung / Service Instructions

1**2****3**

Alle Rechte vorbehalten.

Eigentum der Dürkopp Adler AG und urheberrechtlich geschützt. Jede, auch auszugsweise Wiederverwendung dieser Inhalte ist ohne vorheriges schriftliches Einverständnis der Dürkopp Adler AG verboten.

All rights reserved.

Property of Dürkopp Adler AG and copyrighted. Reproduction or publication of the content in any manner, even in extracts, without prior written permission of Dürkopp Adler AG, is prohibited.

Copyright © 2009 - Dürkopp Adler AG

Foreword

This instruction manual is intended to help the user to become familiar with the machine and take advantage of its application possibilities in accordance with the recommendations.

The instruction manual contains important information on how to operate the machine securely, properly and economically. Observation of the instructions eliminates danger, reduces costs for repair and down-times, and increases the reliability and life of the machine.

The instruction manual is intended to complement existing national accident prevention and environment protection regulations.

The instruction manual must always be available at the machine/sewing unit.

The instruction manual must be read and applied by any person that is authorized to work on the machine/sewing unit. This means:

- Operation, including equipping, troubleshooting during the work cycle, removing of fabric waste,
- Service (maintenance, inspection, repair) and/or
- Transport.

The user also has to assure that only authorized personnel work on the machine.

The user is obliged to check the machine at least once per shift for apparent damages and to immediately report any changes (including the performance in service), which impair the safety.

The user company must ensure that the machine is only operated in perfect working order.

Never remove or disable any safety devices.

If safety devices need to be removed for equipping, repairing or maintaining, the safety devices must be remounted directly after completion of the maintenance and repair work.

Unauthorized modification of the machine rules out liability of the manufacturer for damage resulting from this.

Observe all safety and danger recommendations on the machine/unit! The yellow-and-black striped surfaces designate permanent danger areas, eg danger of squashing, cutting, shearing or collision.

Besides the recommendations in this instruction manual also observe the general safety and accident prevention regulations!

General safety instructions

The non-observance of the following safety instructions can cause bodily injuries or damages to the machine.

1. The machine must only be commissioned in full knowledge of the instruction book and operated by persons with appropriate training.
2. Before putting into service also read the safety rules and instructions of the motor supplier.
3. The machine must be used only for the purpose intended. Use of the machine without the safety devices is not permitted. Observe all the relevant safety regulations.
4. When gauge parts are exchanged (e.g. needle, presser foot, needle plate, feed dog and bobbin) when threading, when the workplace is left, and during service work, the machine must be disconnected from the mains by switching off the master switch or disconnecting the mains plug.
5. Daily servicing work must be carried out only by appropriately trained persons.
6. Repairs, conversion and special maintenance work must only be carried out by technicians or persons with appropriate training.
7. For service or repair work on pneumatic systems, disconnect the machine from the compressed air supply system (max. 7-10 bar). Before disconnecting, reduce the pressure of the maintenance unit. Exceptions to this are only adjustments and functions checks made by appropriately trained technicians.
8. Work on the electrical equipment must be carried out only by electricians or appropriately trained persons.
9. Work on parts and systems under electric current is not permitted, except as specified in regulations DIN VDE 0105.
10. Conversion or changes to the machine must be authorized by us and made only in adherence to all safety regulations.
11. For repairs, only replacement parts approved by us must be used.
12. Commissioning of the sewing head is prohibited until such time as the entire sewing unit is found to comply with EC directives.
13. The line cord should be equipped with a country-specific mains plug. This work must be carried out by appropriately trained technicians (see paragraph 8).



It is absolutely necessary to respect the safety instructions marked by these signs.

Danger of bodily injuries !

Please note also the general safety instructions.



Foreword and general safety instructions

Part 1: Operating Instructions Class 540-100-1

(Edition: 09/2009)

1. Product description	
1.1 Designated use	5
1.2 Subclasses	6
2. Technical data	6
3. Operating the machine head	
3.1 Needle threading	7
3.2 Winding the hook thread	8
3.3 Changing the bobbin.	8
3.4 Changing the needle	10
3.5 Changing the knife	11
3.6 Checking the knife height	12
3.7 Thread tension (540-100).	13
3.8 Electronic thread tension (540-100-1)	15
3.9 Regulating the sewing basket lifting height	16
3.10 Regulating the sewing basket pressure	16
4. Control panel and control unit	
4.1 Control panel	17
4.1.1 Control panel elements	18
4.2 Changing parameter values	19
4.2.1 Numerical values	19
4.2.2 Parameter selection	19
4.3 Main menu	20
4.4 Hook thread monitoring	21
4.4.1 Hook thread counter adjustment.	21
4.5 Soft start on / off	22
4.6 Sequences.	22
4.6.1 General.	22
4.6.2 Switching the sequence mode on / off	23
4.6.3 Select a sequence in the sequence mode (Main menu).	23
4.6.4 Automatic or manual mode	23
4.7 Programming of sequences.	24
4.7.1 Programming of a single sequence	24
4.7.2 Adding a buttonhole at the end of a sequence	25
4.7.3 Deleting a buttonhole within the buttonhole sequence.	25
4.7.4 Inserting a buttonhole within the buttonhole sequence	25

5.	Buttonhole programming	
5.1	Composition of a buttonhole	26
5.2	Submenu programming (general view)	28
5.3	Parameter programming mode.	29
5.4	Adjusting the cut length	30
5.5	Selecting a start variant	30
5.6	Setting buttonhole seam	31
5.7	Setting bartack	32
5.7.1	Selectable bartack types	32
5.7.2	Programming menu "bartack"	33
6.	Knitwear mode	
6.1	Selecting or switching off knitwear mode.	37
6.2	Submenu basting stitch	38
6.3	Submenu zigzag	38
7.	Sewing procedure	
7.1	Normal sewing procedure.	39
7.2	Interruption of sewing procedure	39
7.2.1	Interruption by the operator.	39
7.2.2	Clearing thread breakage.	39
8.	Error messages	41
9.	Maintenance	
9.1	Cleaning and inspection.	44
9.2	Oil lubrication	45

1. Product description

The Dürkopp Adler 540-100-1 is a CNC double lockstitch buttonhole machine with stepping motor technology for the sewing of flat form linen button holes in light to medium weight material. Maximum buttonhole length is 65 mm and maximum buttonhole width is 6 mm (equipment dependent).

Including a knife for all cutting lengths, longitudinal or transversal setting possible, fine adjustment of the buttonhole with the push of a button, integrated direct DC drive.

Additional functions:

- Selectable bartack forms :
Cross tack (vertical), Cross tack (horizontal), Cross tack (divided), Round tack (to the middle point), Round tack (horizontal), Taper tack, Eye tack, Simple tack, Snaffle-shaped tack
- 50 variable seam makers
- 20 Buttonhole – each sequence can be programmed with a maximum of 20 buttonholes
- Programmable sewing revolution to a max. of 4000 stitches/min
- Soft start
- Bobbin capacity meter
- Daily quantity meter
- Multi test functions
- Voltage rating: 1 x 190 - 240V 50/60Hz

1

1.1 Designated use

The **DÜRKOPP ADLER 540-100-1** is an automatic sewing machine designed for sewing buttonholes in light to medium-heavy material.

Such material, which is generally made of textile or synthetic fibres, is used in the clothing industry. This sewing machine can also be used to produce so-called technical seams. In this case, however, the operator must assess the possible dangers which may arise (with which DÜRKOPP ADLER would be happy to assist), since such applications are on the one hand relatively unusual and, on the other, they are so varied that no single set of criteria can cover them all. The outcome of this assessment may require appropriate safety measures to be taken. Generally only dry material may be sewn with this machine. The material may be **no thicker than 4 mm** when compressed by the lowered upper material sewing basket.

The material may not contain any hard objects. The machine may only be operated with finger and eye protection. The seam is generally produced with sewing threads of gauge up to 65/2 Nm (synthetic threads with or without cotton covering). Before using any other thread the possible dangers arising must be assessed and appropriate safety measures taken if necessary. This machine may be set up and operated only in dry, well-maintained premises. If it is used in other premises which are not dry and well-maintained it may be necessary to take further precautions (which should be agreed in advance - see EN 60204-31: 1999). As manufacturers of industrial sewing machines we proceed on the assumption that personnel who work on our products will have received training at least sufficient to acquaint them with all normal operations and with any hazards which these may involve.

1.2 Sub classes

540-100-1

For the sewing of raised-form or flat-form linen buttonholes in light to middle weight material, with electronically driven thread tensioner. Buttonhole length max. 70 mm, buttonhole width max. 6 mm. A knife for all cut lengths.

2. Technical data

Machine head:	Class 540-100-1
Needle system:	System 265 with slightly rounded head
Needle thickness:	70 – 100 (dependent on equipment)
Threads:	Synthetic thread and synthetic thread with cotton covering up to 65/2 Nm
Stitch type:	Double lockstitch (304)
Stitch number:	Max. 4000 RPM (adjustable)
Double stitch distance:	0,2 - 3 mm
Sewing foot stroke:	12 mm
Buttonhole length :	6 - 70 mm (dependent on equipment)
Buttonhole width:	3 - 6 mm (dependent on equipment)
Cut length:	6 - 65 mm
Power rating:	1,3 kW
Operating pressure:	6 bar
Air consumption:	approx.4 NL per working cycle
Rated voltage:	1 ~ 230 V, 50/60 Hz 1~ 190 - 240 V, 50/60 Hz
Frame:	1060 x 620 x 1250 mm (L x B x H)
Work height:	780 - 880 mm (Top edge of table top)
Weight:	ca. 100 kg (with frame) ca. 70 Kg (without frame)
Rated noise level :	Lc = 79 dB (A) Emission value per workplace according to DIN 45635-48-B-1 (sewing cycle 3.6 s ON and 1.0 s OFF). Buttonhole width: 4 mm Cutting length: 17 mm Speed: 4.000 min ⁻¹ Stitch length: 0.6 mm Fabric: G1 DIN 23328 two-ply

3. Operating the machine head

3.1 Needle threading



Caution: Danger of injury !

The needle should only be threaded when the sewing automat is switched off.

- Thread needle according to diagram

540-100-1

540-100

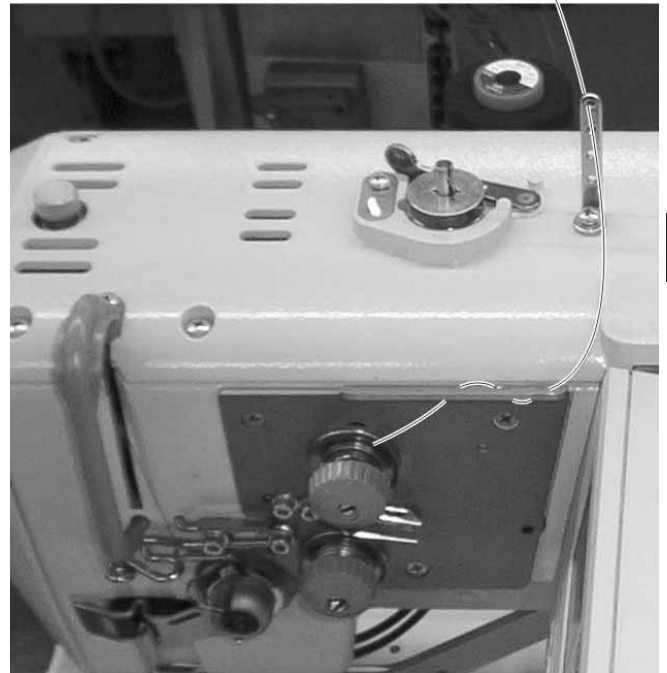
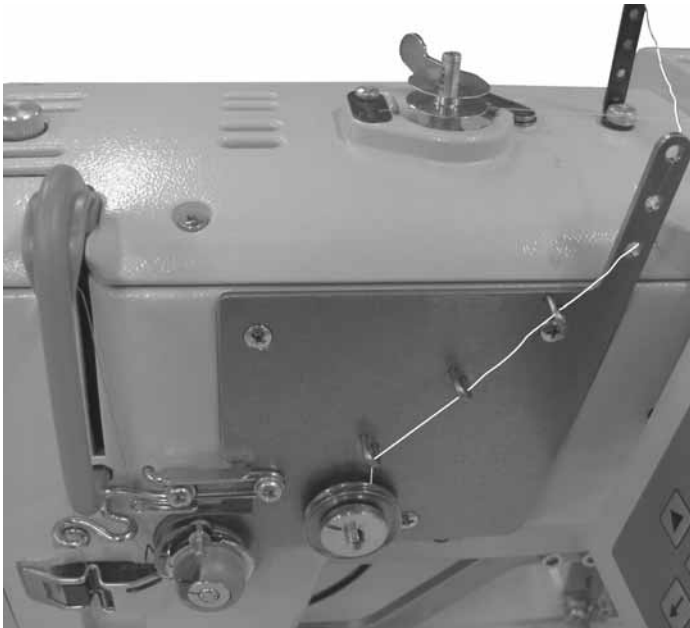

1

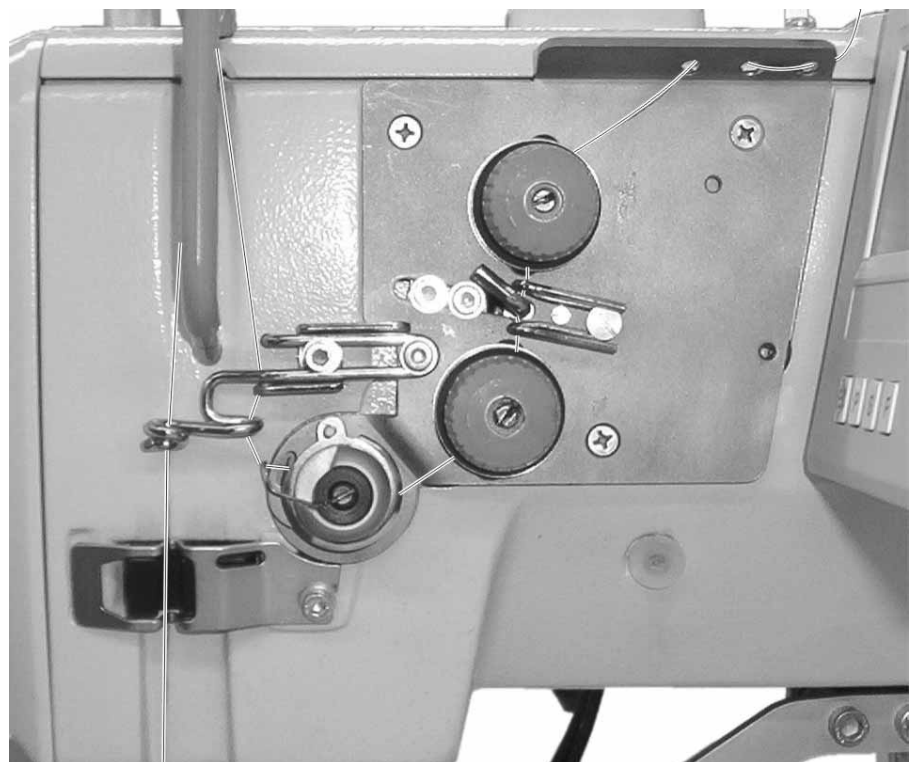

3.2 Winding the hook thread



Threading the hook thread is independent of sewing operation.

- Put the thread on the thread stand.
- Thread the hook as shown in the picture.
- Put the empty bobbin onto the bobbin winder 1.
- Wind the hook thread clockwise about 5 times around the bobbin core.
- Swing winder lever 2 towards spool and click in. The thread will be wound on.
- Winder lever 2 ends the spooling event when the bobbin is full.
- After spooling snap out the bobbin thread from thread clamp 3.

3.3 Changing the bobbin



Caution: Danger of injury !

The bobbin should only be changed when the sewing automat is switched off.

Remove empty bobbin.

- Open bobbin case lid.
- Flip up the clip 5 and remove the top of the bobbin housing with bobbin.
- Remove the bobbin from the top of the bobbin housing.

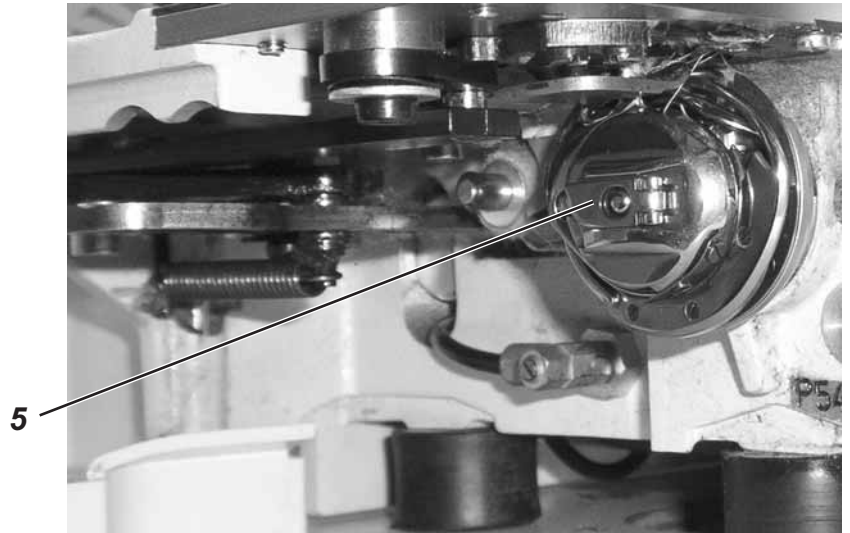

Threading the bobbin

- Place the full bobbin in the bobbin housing top, whereby the bobbin has to turn in anti-clockwise direction when the hook threader is pulled.
- Pass the hook thread through the slit 6 and under the spring.
- Dependent on chosen buttonhole the hook thread has to go through slit 9 for raised-form buttonholes and slit 10 for flat-form buttonholes.

1

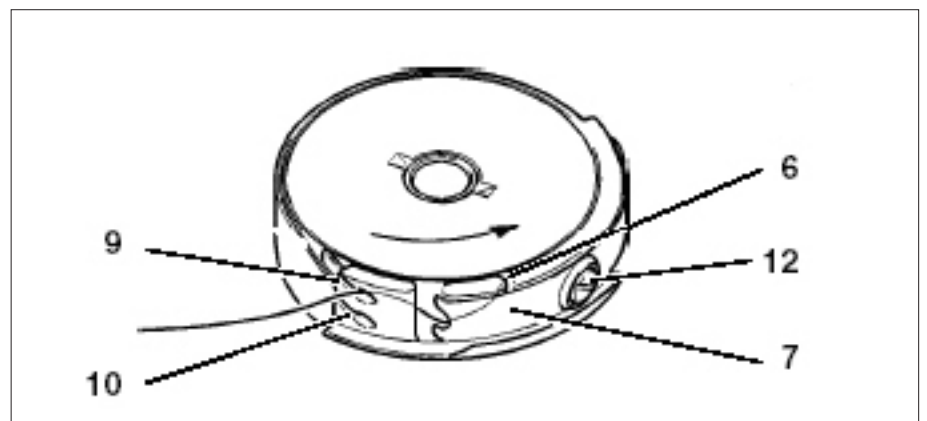

Setting the hook thread tension

- Set the hook thread tension by turning screw 12 so that the bobbin housing slowly sinks with its own weight when the hook thread is held tight.
- Flat-form buttonholes will require a higher tension.

Fitting of bobbin housing

- Put the bobbin housing top along with the bobbin on the bobbin housing bottom, make sure that the clip 5 audibly snaps into place.
- Close bobbin case lid.

3.4 Changing the needle



Caution: Danger of injury !

Switch off at main power switch ! Only change the needle when the sewing automat is switched off !

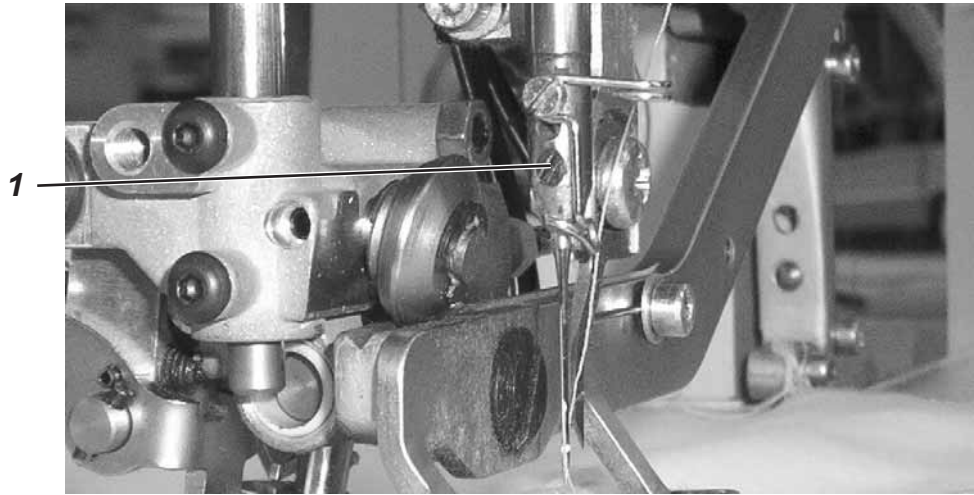

- Loosen screw 1.
- Pull needle from the needle bar.
- Insert the new needle to the stop in the bore of the needle bar.
- Set the needle so that the needle scarf lies on the backward facing side of the knife.
- Tighten screw 1.



CAUTION !

If the needle thickness is changed, the distance between the hook and the needle may need to be changed.

3.5 Changing the knife



Caution: Danger of injury !

Switch off at main power switch ! Only change the knife when the sewing automat is switched off !



CAUTION !

Ensure that the lifted basket has a minimum distance of 1mm between the upper thread scissors and the bottom knife edge.

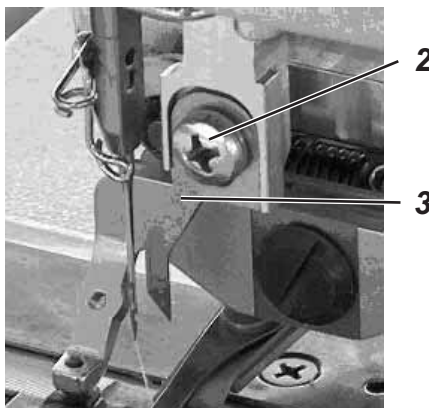

Knife removal

- Loosen screw 2.
- Remove knife 3.

Knife insertion

- Insert new knife and set it right at the top.
- Tighten screw 1.



Note!

If the cut does not occur in the middle of the buttonhole or not parallel to the buttonhole seam, the knife needs to be readjusted.

Instructions for service 540-100-1, Chapter: Knife adjustment.

3.6 Checking the knife height

Rule:

The knife point is needed only when diving into the material. The knife point should not leave the throat plate during the cutting procedure.



CAUTION !

Ensure that the lifted basket has a minimum distance of 1mm between the upper thread scissors and the bottom knife edge.

Note !

When a knife is sharpened, its length will be shorter. With the insertion of the sharpened knife the knife height may need to be corrected.

Adjusting:

- Position the material under the clamp and start the sewing process.
- Stop the sewing process during the cutting process on the reverse buttonhole seam stitch by pushing the pedal backwards.
- Make the slit on the throat plate visible by pulling the material a little away from the clamp.
- Turn the hand wheel in the direction of rotation until the knife has reached its highest position to the throat plate.
- In this position 0.2 mm of the knife point should remain dipped in the throat plate slit.
- Knife height adjustment: Loosen screw 1. Push the knife as far as needed until the correct knife position has been reached. Re-tighten screw 1.
- Loosen screw 3.
- Push stop 2 right up to the knife
- Re-tighten screw 3.
- End the sewing process by pushing the pedal backwards.

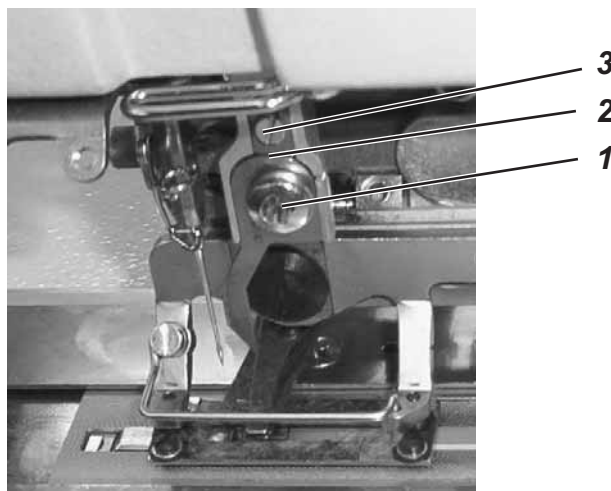

3.7 Thread tension (540-100)



Thread tension 1

The tension serves the purpose of sewing flat-form tacks and buttonhole seams.

The tension is always effective and opens only with thread cutting.

Thread tension 2

The thread tension can be switched on and off. The complete tension of thread tension 1 and thread tension 2 generate raised-form tacks and buttonhole seams. The selection can be freely programmed for each buttonhole section of a buttonhole.

The tension is only effective if programmed and opens during thread cutting.

Check:

- Thread the needle and hook thread with different coloured yarn.
- Make a trial seam.
- For the flat parts of the buttonhole the cross-over point of the thread should be in the middle of the material.
Setting: Change the thread tension 1
- For the raised parts of the buttonhole the cross-over point of the thread should be on the top side of the material.
Setting: Change the thread tension 2 until the seam pattern is regular.

With the correct setting, in the flat buttonhole parts the upper thread and in the raised buttonhole parts only the looper thread will be visible on the material top side.

Increase tension

Turn knurled nut clockwise.

Reduce tension

Turn knurled nut anti-clockwise.

Notes:

3.8 Electronic thread tension (540-100-1)

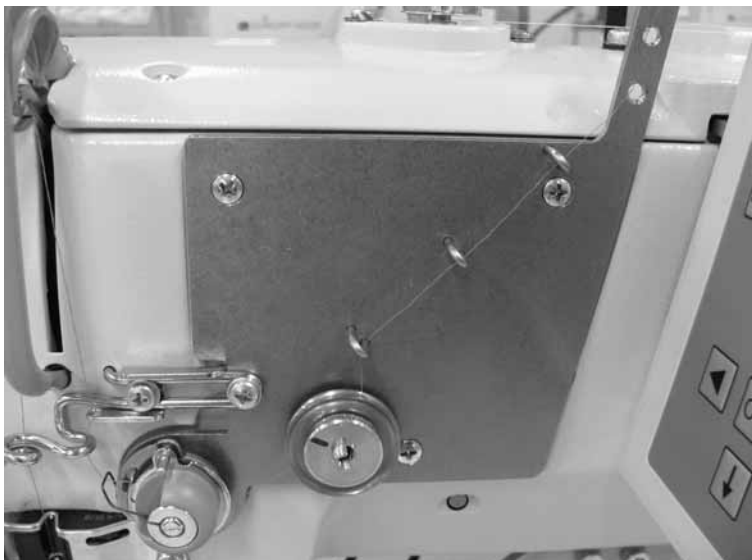

1

Setting or altering the thread tension values

- Switch on the machine.
- Display the main menu.
- Select the menu item "Thread tension" using the ▲ and ▼ keys and confirm by pressing "OK".

		<i>Explanation</i>
	Seam [%] : value (e.g. 35)	<i>Changes the forward/backward seam</i>
	Bartack [%] : value (e.g. 20)	<i>Changes the upper/lower bartack</i>
<hr/>		
	Seam (fwd.) [%] : value (e.g. 35)	<i>Different values for forward seam (leading)</i>
	Upper bartack [%] : value (e.g. 20)	<i>Different values for upper bartack</i>
	Seam (bw.) [%] : value (e.g. 35)	<i>Different values for backward seam (trailing)</i>
	Lower bartack [%] : value (e.g. 20)	<i>Different values for lower bartack</i>
<hr/>		
<i>Knitwear mode invoked</i>	1 st stitch [%] : value (e.g. 10)	
	Start [%] : value (e.g. 15)	<i>Seam beginning area</i>
	End [%] : value (e.g. 15)	<i>Knotting area of the stitch</i>
	<hr/>	
	Basting stitch [%] : value (e.g. 15)	<i>Tension of the straight securing stitches</i>
	1 ZZ ↑ [%] : value (e.g. 20)	<i>Forward seam of the knitted fabric</i>
1 ZZ ↓ [%] : value (e.g. 20)	<i>Backward seam of the knitted fabric</i>	
<hr/>		
Copying No.:		

3.9 Regulating the sewing basket lifting height

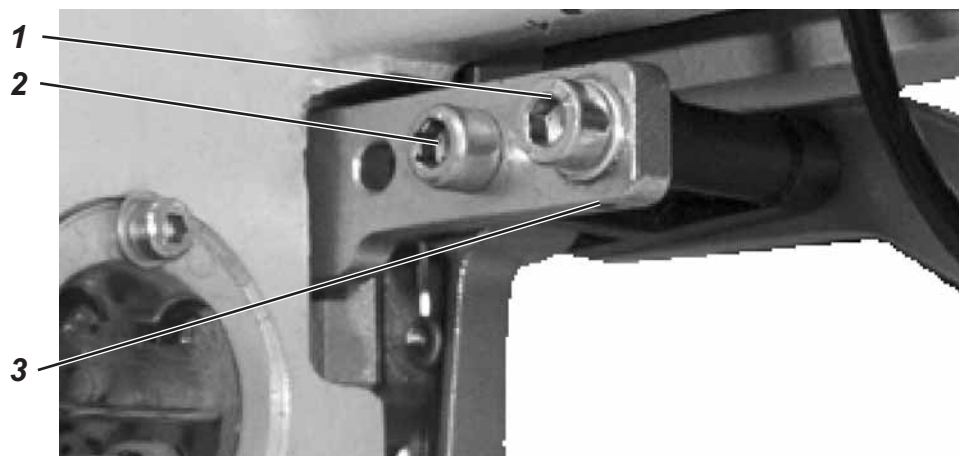

CAUTION !

Ensure that,

- a distance of at least 1 mm lies between top thread cutter and the knife bottom edge of the lifted basket
- the knife point does not protrude out of the basket bottom.

Factory setting for the basket lifting height is 12 mm. Adjust the basket lifting height in the following way:

- Switch off the machine.
- Loosen screws 1 and 2.
- **Increase the basket lifting height:** Turn set screw 3 clockwise.
- **Reduce basket lifting height:** Turn set screw 3 anti-clockwise.
- Tighten screws 1 and 2.
- Switch on the machine and check settings.

3.9 Regulating the sewing basket pressure

- The sewing basket pressure is adjusted using screw 4.

Increase pressure: Turn screw 4 clockwise.

Reduce pressure: Turn screw 4 anti-clockwise.



4. Control panel and control unit

In this operating manual only the functions of the keys and the parameter changes that the operator can make are listed.

4.1 Control panel







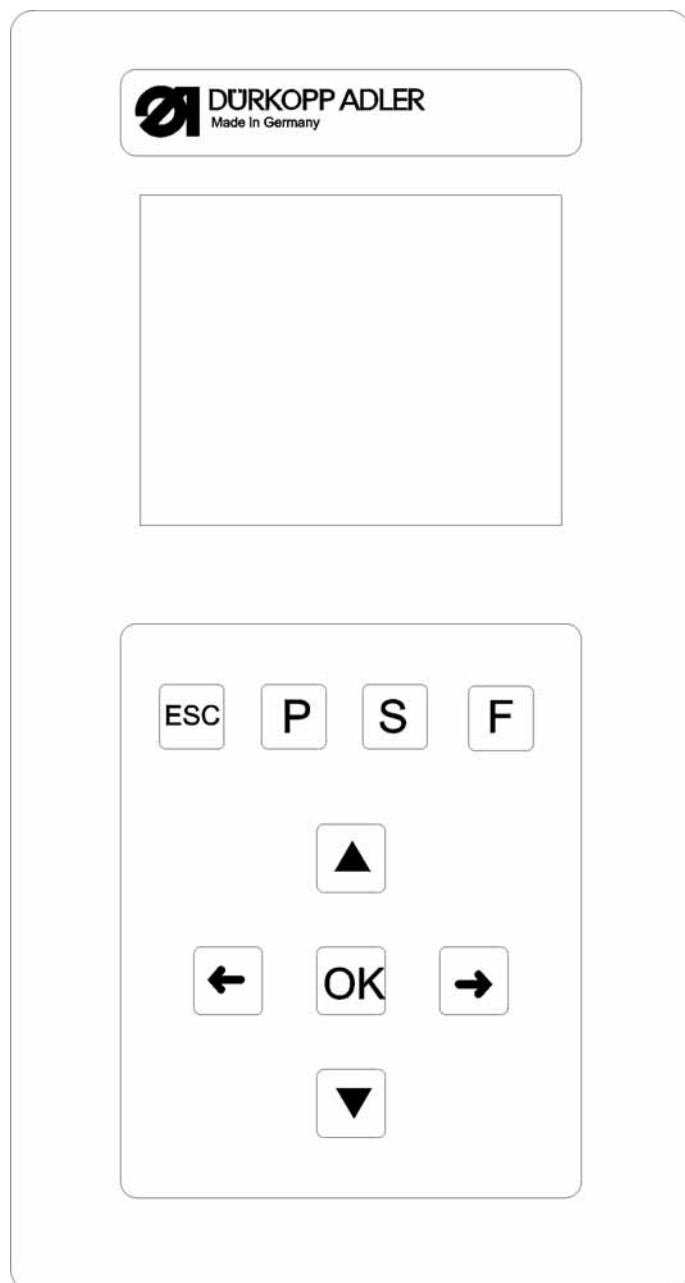



Through the operating panel the control is programmed and the functions for the respective seams are set. This occurs partly through direct pressing of the corresponding key or through parameter adjustment. The input of parameters occurs in programming mode "P". The parameter and the corresponding values are shown on the display. In order to avoid inadvertent changes of parameters, the operation of the control panel is sub-divided into several levels (operator, technician, manufacturer)

The operator (seamstress) can directly access his/her level.

Access to other levels is only possible after the input of a code number.



4.1.1 Control panel elements

Key	Function
	<p>When no input panel is activated:</p> <ul style="list-style-type: none"> – Change to the higher level menu.
 	<ul style="list-style-type: none"> – In the main menu, change between the buttonhole programs within a sequence. <p>When an input panel is activated:</p> <ul style="list-style-type: none"> – Change between the digits tenths, units and tens.
 	<ul style="list-style-type: none"> – Change lines within the menu. The active line appears white on black. <p>When an input panel is activated:</p> <ul style="list-style-type: none"> – Increase or decrease the value of the corresponding digit by 1 or with functions having several options change between the options, e.g. “Buttonhole seam tension on” and “Buttonhole seam tension off”.
	<ul style="list-style-type: none"> – Activate the input panel. The value can be changed by using “↑” and “↓” keys . <p>When an input panel is activated:</p> <ul style="list-style-type: none"> – The set value will be accepted
	<ul style="list-style-type: none"> – Change from a submenu back to sewing mode. – Resolve a thread breakage – repair mode, the basket drives to the end position, raises and releases the material – After stopping the sewing procedure the basket drives to the end position, raises and releases the material <p>When an input panel is activated:</p> <ul style="list-style-type: none"> – An input is discontinued. The previous value remains valid.
	<ul style="list-style-type: none"> – The control changes from sewing mode to programming mode. The buttonhole parameters can be changed in this mode.
	<ul style="list-style-type: none"> – The control changes from either the sewing mode or programming mode to the sequence programming mode.
	<ul style="list-style-type: none"> – The control changes from the sewing mode to the technician mode. This mode can only be activated by entering a code. In this operating condition basic machine parameters can be set, diagnosis and calibration programs can be started

4.2 Changing parameter values

4.2.1 Numerical values

Numerical values can be altered in the following ways:

- With the arrow keys \uparrow and \downarrow choose the line in which the value needs to be changed.
- Press the **OK** key.
The cursor blinks under the position of the value to be changed.
- With the arrow keys \leftarrow and \rightarrow change between the values.
- With the arrow keys \uparrow and \downarrow increase or decrease the chosen value.
With parameters that can not be arbitrarily changed, by pressing of the arrow keys \uparrow and \downarrow another possible parameter is shown on the display.
- Press the **OK** key.
The set value will be accepted.
- If the set value is not to be accepted, press the **ESC**-key.
The original value or setting will be reestablished.









4.2.1 Parameter selection

With some parameters several choices are available.

The parameter can be changed in the following way:

- With the arrow keys \uparrow and \downarrow choose the line with the parameter to is be changed.
- Press the **OK** key.
- With the arrow keys \uparrow and \downarrow change between the possibilities. The respective parameter is shown.
- Press the **OK** key. The set value or parameter will be accepted.
- If the set value or parameter is not to be accepted, press the **ESC**-key.
The original value or parameter setting will be reestablished.

4.3 Main menu

Symbol	Parameter	Meaning
	Buttonhole number N1	Selection of the buttonhole to be sewn <ul style="list-style-type: none"> - Program number 1 to 50 contains buttonhole programs. Program number 51 and 52 contain free contour sewing programs. - The preprogrammed form of the chosen buttonhole is shown in the left half of the display. - Additionally an info window is shown with some buttonhole specific values: <ul style="list-style-type: none"> - Cut length - Intermediate fabric - Buttonhole seam stitch length - Buttonhole width
	Thread tension N2	Selection of the submenu for changing the thread tension values. Only visible when the electric thread tension control is activated
	Cut length N3	<ul style="list-style-type: none"> - Selection of buttonhole cut length from 6 – 65 mm - The setting is dependent of the buttonhole number.
	Speed N4	<ul style="list-style-type: none"> - Selection of sewing speed for the buttonhole to be sewn from von 200 - 4000 RPM. The setting is dependent of the buttonhole number. - If the set sewing speed is less than the soft start speed a cautionary warning is displayed and the soft start is switched off. - The high speed that is here selectable can be set in the technician level.
	Soft start N5	Soft start switch on and off <ul style="list-style-type: none"> - Number of soft start stitches and their sewing speed can be preset in the technician level.
	Daily quantity counter N6	The daily quantity counter counts the number of sewn buttonholes. <ul style="list-style-type: none"> - By pressing the "OK"- key twice, the daily quantity counter will be reset to zero.
	Hook thread counter N7	Display of the current hook thread counter state (when active) and selection of the submenu for the changing of the initial value and for the switching on and off of the hook thread counter.
	Repair mode N8	Repair mode.

4.4 Hook thread monitoring

Hook thread monitoring mode of operation:

Hook thread monitoring is carried out by counting the buttonholes. With the insertion of a full bobbin the hook thread counter is set to a predetermined value. This value is subtracted by one with each complete cycle. When the value 0 is reached the operator receives an information message.

There should be some remaining thread on the bobbin.



Note

This principle only functions when the same amount of bobbin thread is used per buttonhole or sequence. Changing frequently the cut length, buttonhole form or buttonhole parameter changes the amount of bobbin thread used per buttonhole.

4.4.1 Hook thread counter adjustment

Select the submenu "Hook thread counter"

- With the \uparrow and \downarrow keys choose in the main menu the line "Hook thread counter".
- Press **OK**- key.
The submenu "Hook thread counter" is displayed.

Submenu "Hook thread counter" displayed parameters:

Current hook thread counter value

N7.1

Sets the display in the main menu to the initial value indicated in N7.2 below.

- With the \uparrow and \downarrow keys select the relevant line.
- By pressing the **OK**-key the indicated value in the main menu will be set to the initial value.
- The display changes automatically back to the main menu.

Initial value

N7.2

Total number of possible buttonholes with the remaining thread on the bobbin.

- Select the relevant line with the \uparrow and \downarrow keys.
- Press the **OK**-key.
The cursor blinks under the position of a numerical value.
- Move between the digits with the keys \leftarrow and \rightarrow .
- Increase or decrease the digit value with the keys \uparrow and \downarrow .
- Confirm with the **OK**-key.
- Choose line N7.1 with the arrow keys \uparrow and \downarrow
- By pressing the **OK**-key the indicated value in the main menu will be set to the initial value.
- The display changes automatically back to the main menu.

7000
 \uparrow
8500

Σ =



Hook thread counter on and off

N7.3

The function of the hook thread counter is either switched on or off.

- Select the relevant line with the ↑ and ↓ keys.
- Press the **OK**-key.
- Select the parameter **On** or **Off** by using the arrow keys ↑ and ↓. The main menu will indicate no parameter with the hook thread counter switched off.

4.5 Soft start on /off

- Select the “**Soft start**” in the main menu with the arrow keys ↑ and ↓.
- Press the **OK**-key.
- Select the parameter **On** or **Off** by using the arrow keys ↑ and ↓.
- Press the **OK**-key.



Note !

The number and sewing speed of the soft start stitch can be preset in the technician level.

If a main sewing speed is less than the soft start sewing speed, the soft start will be automatically switched off.

4.6 Sequences

4.6.1 General

Single buttonhole mode

One buttonhole can be selected from a total of 50 preprogrammed buttonhole programs. Memory locations 51 and 52 can be used for free sewing contours.

This buttonhole will be sewn until another buttonhole is selected.

Sequence mode

The seamstress will be in a position to sew a sequence of different buttonholes without having to push a key on the control panel.

- 20 different sequences can be created and saved in the memory.
- Each sequence can contain up to 20 buttonholes.
- In principle all buttonholes can be selected in one sequence.



Note

A plausibility check of the individual buttonhole parameters is first made when the sequence is selected in the sewing mode!

4.6.2 Switching the sequence mode on / off



Switching the sequence mode on or off

- Press the **S**-key.
The control panel changes to the menu for the programming of buttonholes sequences.
- With the arrow keys \uparrow and \downarrow select the relevant line
- Press the **OK**-key.
- With the arrow keys \uparrow and \downarrow choose between on(sequence mode) or off (single buttonhole mode)
- Confirm by pressing the **OK**-key.
- To return to the main menu press the **ESC**-key.

4.6.3 Select a sequence in the sequence mode (Main menu)

After switching on, the top line of the display will appear white on black. The last used sewing sequence will be displayed.

Select another sequence

- Press the **OK**-key.
- Moving between the sequences can be achieved by using the arrow keys \uparrow and \downarrow .
- Confirm by pressing the **OK**-key.

4.6.4 Automatic or manual mode

02 \Rightarrow 05 \Rightarrow 12 \Rightarrow 09

Automatic operation

In the sequence that is shown on the display, arrows will be displayed between the buttonhole forms.

- After sewing a buttonhole, the control will change automatically to the next buttonhole form.
- After sewing the last buttonhole, the control will change again to the first buttonhole within the sequence.
- The current buttonhole will be indicated with a bar.
- The form of each chosen buttonhole will be shown in the left half of the display.

02 – 05 – 12 – 09

Manual operation

In the sequence that is shown on the display, no arrows will be displayed between the buttonhole forms.

- The control does not change automatically between the buttonhole forms.
- The current buttonhole will be indicated with a bar.
- The form of each chosen buttonhole will be shown in the left half of the display.

Change between automatic and manual operation

- Choose the relevant line in which the current sequence is displayed using the arrow keys \uparrow and \downarrow
- Press the **OK**-key.
- Change between the two operational modes using the arrow keys \uparrow and \downarrow .
- Confirm by pressing the **OK**-key.

Select another buttonhole to be sewn within the sequence

Selection between the different programmed buttonholes is always possible when the sewing menu is displayed

- Press the arrow keys ⇐ or ⇒.

The next or previous buttonhole is selected within the displayed sequence.

4.7 Programming of sequences

Up to 20 buttonhole sequences can be programmed.

Each sequence can contain up to 20 buttonholes.

4.7.1 Programming a single sequence



Select program menu sequence

- Press the key “**S**” on the control panel.
The control panel changes to the buttonhole programming sequence menu.
- Press the **ESC**-key to leave this menu.

Selection of the sequence number

- Select the line for choosing the sequence number with the arrow keys ↑ and ↓.
- Press the **OK**-key.
- Select the sequence number to be programmed with the keys ↑ and ↓.
- Press the **OK**-key to confirm.

Default example: Buttonhole 1: 1
 Buttonhole 2: 0

Programming example: Buttonhole 1: 19
 Buttonhole 2: 2
 Buttonhole 3: 0

Buttonhole sequence programming

- Select line “Buttonhole 1:” with the arrow keys ↑ and ↓
- Press the **OK**-key.
- Select the desired buttonhole program (1 to 50) with the arrow keys ↑ and ↓.
- Press the **OK**-key to confirm the selection.

With the confirmation of the buttonhole program a new menu line appears containing the buttonhole to be programmed next

- The last line of a buttonhole sequence program always shows the buttonhole number “Buttonhole X: 0”, unless all 20 programs are occupied.
- Press the **ESC**-key to return to the main menu.

4.7.2 Adding a buttonhole at the end of a sequence

- Select the last line "Buttonhole X: 0" in the programmed buttonhole sequence with the arrow keys ↑ and ↓.
- Press the **OK**-key.
- Select the desired buttonhole program (1 to 50) with the arrow keys ↑ and ↓.
- Press the **OK**-key to confirm the selection.
With the confirmation of the buttonhole program a new menu line appears containing the buttonhole to be programmed.
- Press the **ESC**-key to return to main menu.

4.7.3 Deleting a buttonhole within the buttonhole sequence

- Select the buttonhole program line that is to be deleted with the arrow keys ↑ and ↓.
- Press the **OK**-key.
- Select **buttonhole program "0"** with the arrow keys ↑ and ↓
- Press the **OK**-key to confirm.

With the confirmation the selected buttonhole will be deleted. Following buttonholes (if any) will move up.

- Press the **ESC**-key to return to the main menu.

4.7.4 Inserting a buttonhole within the buttonhole sequence



Note

The insertion of a single buttonhole program within a buttonhole sequence is not possible.

- Make a note of the programmed buttonholes following.
- Select the desired line of the programmed buttonhole sequence with the arrow keys ↑ and ↓.
- Press the **OK**-key.
- Select the desired buttonhole program (1 to 50) with the arrow keys ↑ and ↓. Press the **OK**-key to confirm the setting.
- Then alter the following buttonholes according to your notes.
- Press the **ESC**-key to return to main menu.

5. Buttonhole programming

5.1 Composition of a buttonhole

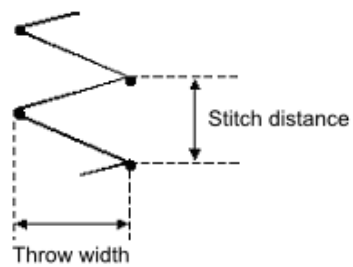
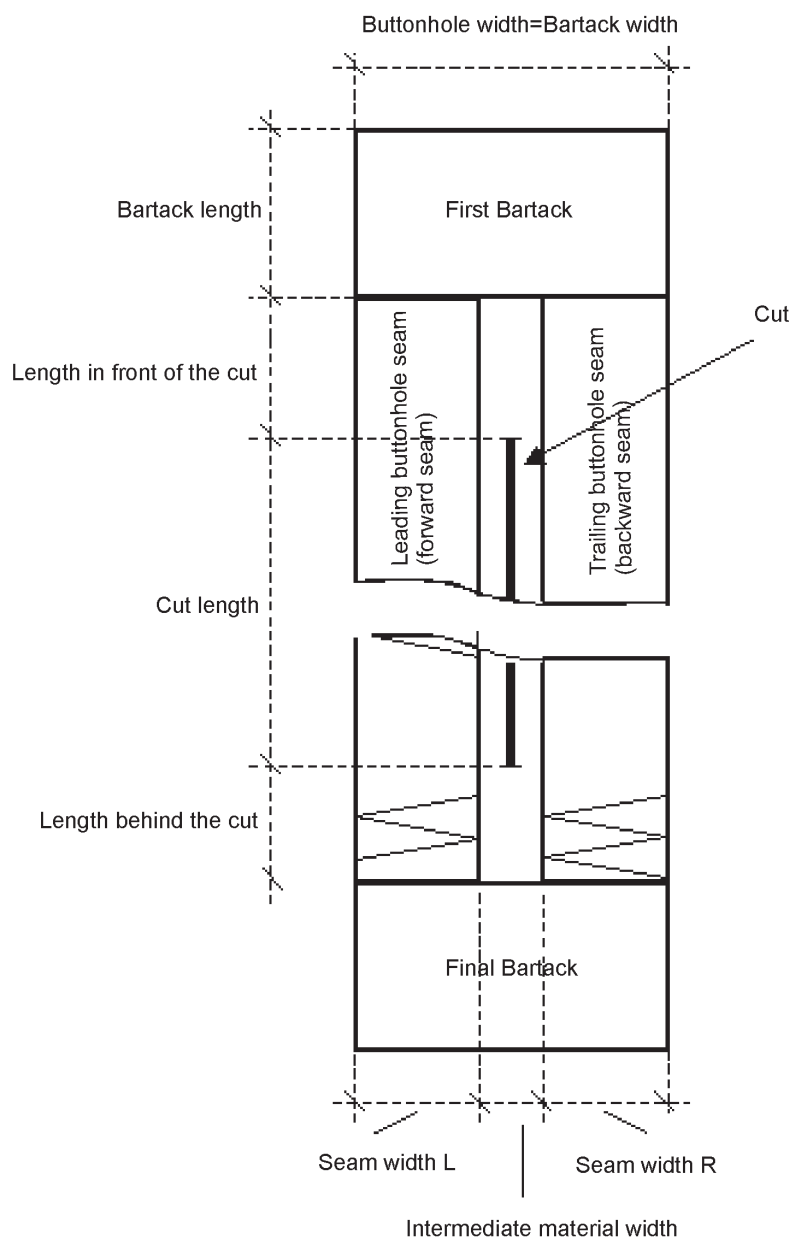

First bartack	First bartack to be sewn in connection to the leading buttonhole seam
Final bartack	Final bartack in connection to the trailing buttonhole seam
Leading buttonhole seam	Buttonhole seam from sewing start to the first bartack
Trailing buttonhole seam	Buttonhole seam between first bartack and final bartack
Buttonhole width	Distance between the outer stitches of a buttonhole
Cut length	Length of the knife's cutting edge in mm
Cut length	Length of the buttonhole to be cut in mm (=Buttonhole seam length)
Intermediate material width	Distance between the inner stitches of the leading buttonhole seam and the trailing buttonhole seam
Throw width	= Buttonhole seam width
Stitch distance	Distance between double stitches in the y-axis
Length in front of the cut	Distance between the first bartack and the cut
Length behind the cut	Distance between the final bartack and the cut







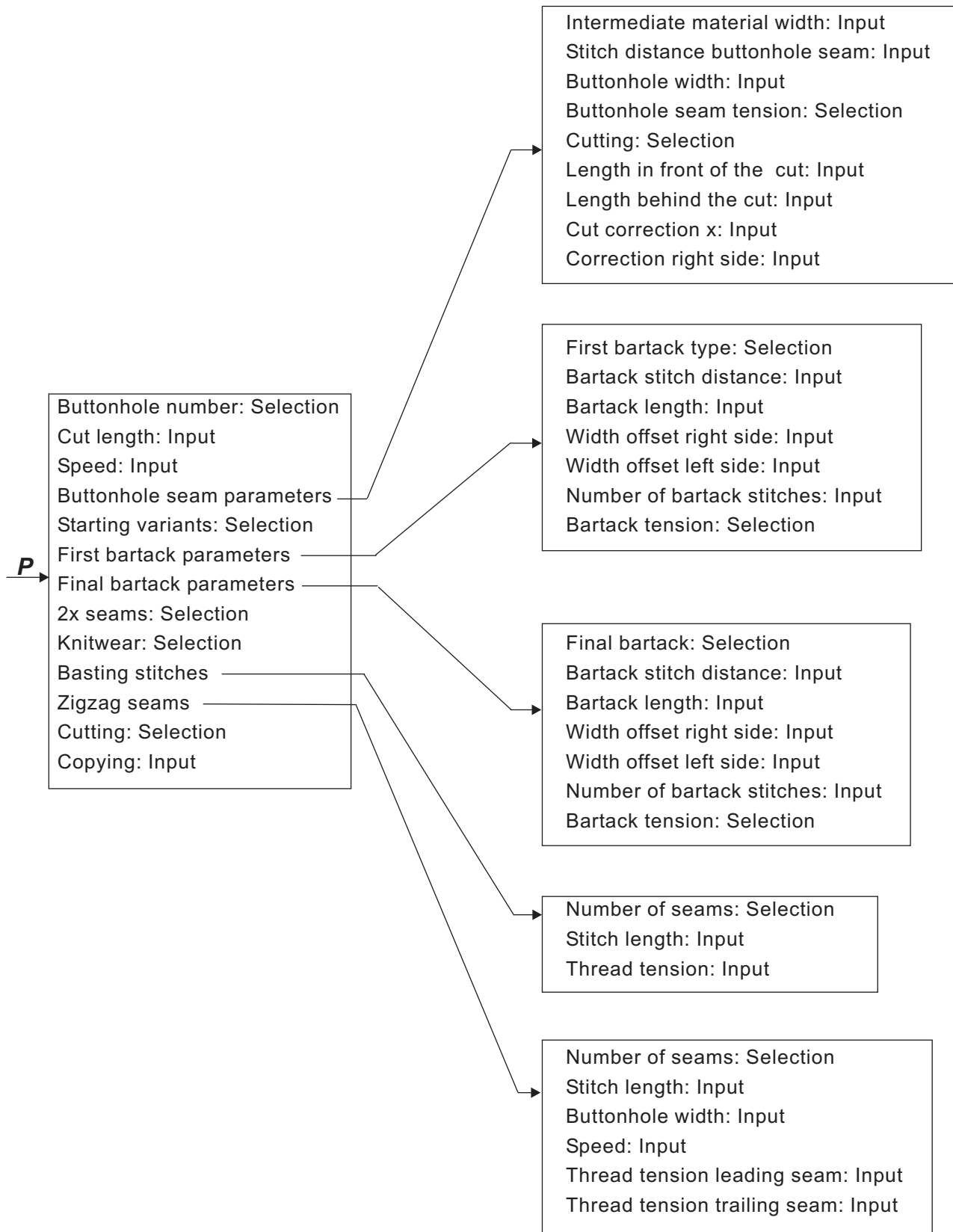





Characteristics

Leading and trailing buttonhole seam	Leading buttonhole seam is symmetrical to the trailing buttonhole seam with the cut length as symmetrical axis.
Buttonhole width = Bartack width	The setting "buttonhole width" automatically gives the bartack width. The bartack width can be altered with the corresponding parameters "offset l" and "offset r" in the bartack menu.
Bartack	The final bartack length is the same as the first bartack length if both bartacks are identical. The bartack length for both is set in the menu "First bartack".
Buttonhole length	The complete buttonhole length is determined by the cut length + length in front of the cut + length behind the cut + first bartack length + final bartack length.

5.2 Submenu program (general view)



5.3 Parameter programming mode

Buttonhole number P1		1 ... 50	Selection of the buttonhole number
Cut length P2		6.0 ... 65.0 mm	
Speed P3		200 ... 4000 RPM	Dependent on buttonhole
Buttonhole seam parameter P4			Select the submenu for the selection of buttonhole seam parameters
Starting variants P5		A,B,C,D	Selection of the sewing start variants
Upper bartack parameter P6			Select the submenu to adjust the upper bartack
Lower bartack parameter P7			Select the submenu to adjust the lower bartack
2x seams P8		ON / OFF	Switching on/off of the double-stitching of the whole buttonhole (the buttonhole is sewn twice).
Knitwear sewing mode P9		ON / OFF	Switching the knitwear sewing mode on or off
Basting stitches P10*			Selection of the submenu for the setting of the number of the basting stitches and the display of the characteristics
Zigzag seams P11*			Selection of the submenu for the setting of a second zigzag seam and the display of the characteristics
Cutting P12*			Cutting during the last cycle Cutting during the cycle before the last one Cutting during both cycles
Copying from P13		0 ... 50	The buttonhole data of the chosen buttonhole number is copied into the currently active buttonhole.

*) Those programs are only visible, if the P9 (Knitwear sewing mode) is switched on.

5.4 Adjusting the cut length



Correcting the buttonhole length (Cut length). The adjustment is possible in both, the main menu and programming mode.

- Select the line “**cut length**” in the main menu with the arrow keys ↑ and ↓
- Press the **OK**-key.
The cursor blinks under a digit value.
- Change between the digits with the arrow keys ← and →.
- Increase or decrease the value of the selected digit with the arrow keys ↑ and ↓.
- Press the **OK**-key to confirm the value.

5.5 Selecting a starting variant



Select a starting variant

The starting variant of the starting stitch serves to ensure the correct sewing start for different materials and threads. The starting variant is individually set for each individual buttonhole.

Starting variant A (Standard)

- The starting stitches are flat form stitches.

Starting variant B (Thin material, lining)

- The starting stitches are flat form stitches. With the use of a cross stitch the upper thread holds better to the material.

Starting variant C (very thin material)

- The starting stitches are flat form stitches.
With the use of forward and backward bartack stitches the upper thread holds better to the material.

Starting variant D (very thin material)

- Alternative to starting variant C.

Select starting variant:

- Press **P**-key.
- Select the line “**Starting variant**” with the arrow keys ↑ and ↓.
- Press the **OK**-key.
- Select the relevant **Starting variant A, B, C** or **D** with the arrow keys ↑ and ↓
- Press the **OK**-key
- Press the **ESC**-key.

5.6 Setting buttonhole seam











In the program menu "Buttonhole seam"

Select program menu Buttonhole seam

















- Press the **P**-key.
- Select the line "**Buttonhole seam**" with the arrow keys \uparrow and \downarrow .
- Press the **OK**-key.
- Select the relevant line with the arrow keys \uparrow and \downarrow .
- Press the **OK**-key. The curser blinks under one of the digit values.
- Change between the digits with the arrow keys \leftarrow and \rightarrow .
- Increase or decrease the value of the chosen digit with the arrow keys \uparrow and \downarrow .
- Press the **OK**-key to confirm. Press the **ESC**-key.

The following parameters can be changed for the buttonhole seam section:

	Intermediate material width P4.1	- 1,0...+1,0 mm	Distance between the inner stitches of the buttonhole seam.
	Stitch distance within the buttonhole seam P4.2	0,3...1,5 mm	Distance in the y-axis of a double stitch.
	Buttonhole width P4.3	1,6...6,0 mm	Overall width of a buttonhole (outer stitches).
	Buttonhole seam tension P4.4	on;off	on: additional thread tension on (raised-form) off: additional thread tension off (flat-form)
	Cutting P4.5	on;off	on: cutting during the sewing cycle off: no cutting
	Length in front of the cut P4.6	-P6.3...5,9 mm	1. Correction of the position of the first tack in relation to the end of the cut 2. Additional buttonhole length in front of the cut with asymmetrical cutting within the buttonhole.
	Length behind the cut P4.7	(1.8 mm - P7.3)- 5,9 mm	1. Correction of the position of the first tack in relation to the end of the cut 2. Additional buttonhole seam length behind the cut with asymmetrical cutting within the buttonhole.
	Cut correction x P4.8	-0,5...+0,5 mm	Position of the cut within the buttonhole on the x-axis.
	Correction right side P4.9		Correction of the right sided buttonhole seam width, only visible with bartack type A (Cross bartack).

5.7 Setting bartack

5.7.1 Selectable bartack types

A	Cross tack (horizontal)	top		
		bottom		
B	Round tack (to the middle point)	top		
		bottom		
C	Taper tack	top		
		bottom		
D	Round tack (horizontal)	top		
		bottom		
E	Cross tack (vertical)	top		
		bottom		
F	Cross tack (divided)	top		
		bottom		
G	Eye tack	top		
		bottom		
H	Simple tack (bartack)	top		always together
		bottom		

The upper and lower tacks of the tack types A to G can be freely combined e.g. G eye tack as the top tack and C taper tack as the lower tack.

The tack type H simple tack (bar tack) cannot be combined.

5.7.2 Programming menu “Bartack”







Select programming menu “Bartack”



- Press the **P**-key.
- Select line “**upper tack**” or “**lower tack**” with the arrow keys \uparrow and \downarrow .
- Press the **OK**-key.
- Select the desired parameter with the arrow keys \uparrow and \downarrow .
- Press the **OK**-key.
- The cursor blinks under a digit of the value.
- Change between digits with the arrow keys \leftarrow and \rightarrow .
- Increase or decrease the selected value with the arrow keys \uparrow and \downarrow .
- Press the **OK**-key to confirm.
- Press the **ESC**-key.

According to the selected bartack type the following parameters can be changed for the bartack section.



P6.1/ P7.1  **A cross tack(horizontal) ,**  **F Cross tack (divided)**

Tack stitch distance P 6.2/ P 7.2		0.2 ... 1.0 mm	Distance in the y-axis of a double stitch.
Tack length P 6.3/ P 7.3		0.6 ... 6.0 mm	Length of the tack in the y-axis. The input of parameter P7.3 is only possible when the top and bottom tack types are not similar!
Tack width Right offset P 6.4/ P 7.4		-1.0 ... 1.0 mm	The width of the tack is defined through the buttonhole width. With the use of the right offset the width of the tack to the right can be increased.
Tack width Left offset P 6.5/ P 7.5		-1.0 ... 1.0 mm	The width of the tack is defined through the buttonhole width. With the use of the left offset the width of the tack to the left can be increased.
Tack tension P 6.7/ P 7.7		on / off	on: raised form tack off: flat form tack



P6.1/ P7.1  **B Round tack (to the middle point)**

Tack stitch number P 6.6/ P 7.6		2 ... 50	Number of stitches, that form the semicircular tack.
Tacking tension P 6.7/ P 7.7		on / off	on: raised form tack off: flat form tack







P6.1/ P7.1  **C Taper tack**

Tack stitch distance P 6.2/ P 7.2		0.2 ... 1.0 mm	Distance in the y-axis of a double stitch
Tack length P 6.3/ P 7.3		0.6 ... 9.0 mm	Length of the tack in the y-axis
Tack tension P 6.7/ P 7.7		on / off	on: raised form tack off: flat form tack



P6.1/ P7.1  **D Round tack (horizontal)**

Tack stitch distance P 6.6/ P 7.6		0.3 ... 1.0 mm	Distance in the y-axis of a double stitch
Tack tension P 6.7/ P 7.7		on / off	on: raised form tack off: flat form tack

P6.1/ P7.1  **E Cross tack (vertical)**





Tack stitch distance P 6.2/ P 7.2		0.2 ... 1.0 mm	Distance in the y-axis of a double stitch
Tack length P 6.3/ P 7.3		0.6 ... 6.0 mm	Length of the tack in the y-axis. The input of parameter P7.3 is only possible when the top and bottom tack types are not similar!
Tack width Right offset P 6.4/ P 7.4		-1.0 ... 1.0 mm	The width of the tack is defined through the buttonhole width. With the use of right offset the width of the tack to the right can be increased.
Tack width Left offset P 6.5/ P 7.5		-1.0 ... 1.0 mm	The width of the tack is defined through the buttonhole width. With the use of left offset the width of the tack to the left can be increased.
Moving tack at the top P 6.6/ P 7.6		-1.0 ... 0 mm	The position of the tack can be pushed down.
Moving tack at the bottom P 6.6/ P 7.6		0 ... 1.0 mm	The position of the tack can be pushed up.
Tack tension P 6.7/ P 7.7		on / off	on: raised form tack off: flat form tack

P6.1/ P7.1  **G Eye tack**

Tack width P 6.5/ P 7.5		2.0 ... 6.0 mm	External diameter of the eye
Tack stitch number P 6.3/ P 7.3		2 ... 50	Number of outer stitches, that will form the semicircular tack.
Tack tension P 6.7/ P 7.7		on / off	on: raised form tack off: flat form tack

P6.1/ P7.1  **H Simple tack (bartack),**

The parameter of the special tack types H simple tack are changed with the buttonhole seam parameters.

Stitch distance within the buttonhole seam P4.2		0.2 ... 1.0 mm	Distance in the y-axis of a double stitch
Buttonhole width P 4.3		1.0 ... 6.0 mm	Total width of the buttonhole
Buttonhole seam tension P 4.4		on / off	on: raised form off: flat form
Stitch length of tacking stitches P 4.6		0.2 ... 3.0 mm	Stitch distance of tacking stitches
Thread tension of tacking stitches P 4.7		on / off	Tacking stitch seam resistance

6. Knitwear mode

Use the knitwear mode when stretchable material is to be sewn. In the knitwear mode buttonholes are seamed several times in order to ensure a higher stability.

It is possible to combine a straight basting stitch with a following single or double zigzag. It is also possible to choose whether cutting should take place during the last seam sewing or the one before. The following modes are available:

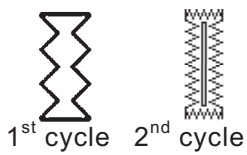

- Combination “1”
Double zigzag
Cutting during the last cycle.

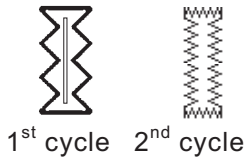

- Combination “2”
Double zigzag
Cutting during the cycle before the last one.

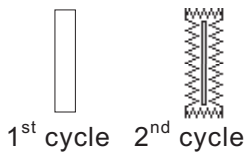

- Combination “3”
Basting stitches on
Cutting during the last cycle.

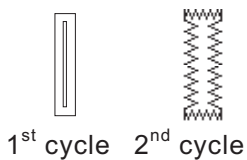

- Combination “4”
Basting stitches on
Cutting during the cycle before the last one.

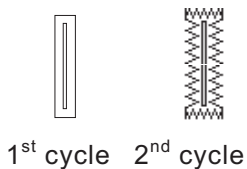

- Combination “5”
Basting stitches on
Cutting during the last cycle and the one before.

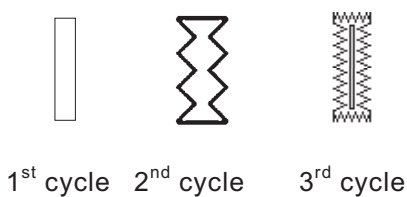

- Combination “6”
Basting stitches on
Double zigzag
Cutting during the last cycle.

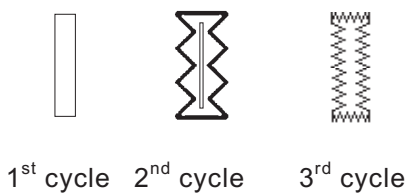

- Combination “7”
Basting stitches on
Double zigzag
Cutting during the cycle before the last one.

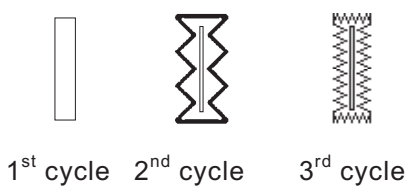

- Combination “8”
Basting stitches on
Double zigzag
Cutting during the last cycle and the one before.

6.1 Selecting or switching off knitwear mode



Select knitwear mode

- Press the **P**-key.
- Select the parameter “**Knitwear**” with the arrow keys \uparrow and \downarrow .
- Press the **OK**-key.
- Select the setting “on” with the arrow keys \uparrow and \downarrow .
- Press the **OK**-key to confirm the selection.



While the knitwear mode is activated the following menu points are visible:

- P9: Basting stitches
- P10: Zigzag seams
- P11: Early cutting (cutting during the cycle before the last one)
[Only visible when the seam cycles basting stitch + zigzag >1]

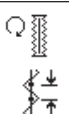

Switching the knitwear mode off

- Press the **P**-key.
- Select parameter “**knitwear**” with the arrow keys \uparrow and \downarrow .
- Press the **OK**-key.
- Select with the arrow keys \uparrow and \downarrow setting “off”.
- Press the **OK**-key.
The knitwear mode is switched off.

6.2 Submenu basting stitches

Seam cycles P9.1		0 / 1	Number of the basting stitch seam cycles
Stitch length P 9.2		0.3 ... 3.0 mm	Stitch length of the basting stitches
Thread tension P 9.3		0...100%	Value of the tread tension for basting stitches. This parameter can only be selected when electric thread tension control is available.

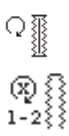
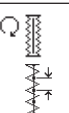
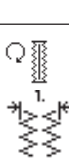
6.3 Submenu Zigzag

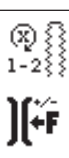
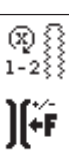
Seam cycles P10.1		1 / 2	Number of the zigzag seam cycles
Stitch length P 10.2		0.3 ... 3.0 mm	Stitch length of the first zigzag. Only visible when the number of zigzag seam cycles = 2
Buttonhole width P10.3		1.0...P4.3	The buttonhole width for the first zigzag \leq max. buttonhole width P4.3. Only visible when the number of zigzag seam cycles = 2
Speed P10.4		200 ... 4000 RPM	The sewing speed of the first zigzag.
Thread tension P 10.5		0...100%	Thread tension for the leading buttonhole seam of the first zigzag. Only visible when the number of zigzag seam cycles = 2. This parameter can only be selected when electric thread tension control is available.
Thread tension P 10.6		0...100%	Thread tension for the trailing buttonhole seam of the first zigzag. Only visible when the number of zigzag seam cycles = 2. This parameter can only be selected when electric thread tension control is available.

7. Sewing procedure

7.1 Normal sewing procedure



Switching on of the automat

- Check on the maintenance unit that an air pressure of 6 bar is present.
- Switch on the main switch of the automat.
- The machine software will be loaded.
- The needle goes to the reference position.
- The sewing basket goes to the reference position and raises.
- The automat is ready to sew.

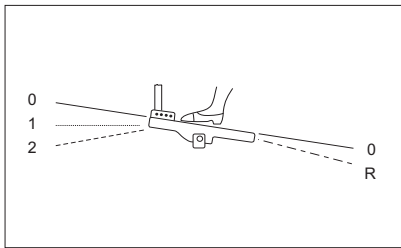

Sewing

- Position material to be sewn under the raised sewing basket.
- Press the foot pedal forward to position 1. The sewing basket descends. Releasing the pedal causes the sewing basket to raise again.
- Push the pedal forward to position 2. The sewing procedure will begin.
- After the sewing procedure the automat goes to the reference position and the sewing basket is lifted.
- The sewn material can be removed.

1

7.2 Interruption of sewing procedure

7.2.1 Interruption by the operator

Interruption by the operator

- Push the pedal backwards.

The machine stops and the needle is driven up high, the sewing basket stays down.

When the material has to be removed:

- Push the pedal backwards again, the automat goes to the reference position and the sewing basket is lifted.

When the sewing procedure is to be started again

- Push pedal forwards to position 2.
- If during the interruption the handwheel has been turned, a continuation is no more possible.

7.2.2 Clearing thread breakage

Thread monitoring

A thread breakage in the upper thread is detected by an electronic upper thread monitor.

Thread breakage

- The automat stops after a thread breakage has been detected by the upper thread monitor. The knife is switched off, the needle is driven up high, the sewing basket stays down and goes with the material to the basket reference position. The message thread breakage is displayed.
- The automat now has to be turned off.

- Hook and needle thread can now be threaded or checked.
- Further measures according to the thread breakage modes **Method A, B** or **C** preset in the technician level (see thread breakage mode).
- By pressing the **ESC**-key the thread breakage mode can be ended. The automat references, the sewing basket is lifted and the material is released.

Thread breakage mode

There are three possibilities to clear a thread breakage. The respective method has to be preset in the technician level.

Method A:

The buttonhole has to be undone and re-sewn.

- After switching the automat on again, the sewing basket is lifted and releases the material.

The automat is now available for a new sewing cycle.

Method B:

The buttonhole is completely re-seamed.

- After switching on again the sewing basket stays down. The material under the sewing basket remains in position.
- Push pedal forwards to position 2 . Sewing begins.
- After sewing the automat drives to the reference position and the sewing basket is lifted.
- The material can be removed.

The automat is now ready for the next sewing cycle.

Method C:

The buttonhole will continue to be sewn beyond the detected thread breakage spot.

- After the automat is switched on again, the sewing basket stays down. Thus the material under the sewing basket remains in position.
- Push the pedal forwards to position 2. The sewing basket proceeds with the material to the thread breakage spot.
- In order to reach the position to continue sewing without having to sew, use the arrow keys \uparrow and \downarrow .
- Push the pedal forwards to position 2. Sewing begins.
- After sewing the machine drives to the reference position and the sewing basket is lifted.
- The material can be removed.
The automat is now ready for the next sewing cycle.

The number of stitches that the thread breakage monitor does not register before signalling an error is set in the technician level. With the setting **stitch number "0"**, the thread breakage monitor is switched off.

8. Error messages

Number	Error position	Description	Cause	Error elimination
1052	Sewing motor	Overcurrent	- Sewing motor cable - Sewing motor - Control	- Check sewing motor cable - Check sewing motor - Check control
1053	Sewing motor	Overvoltage	Mains too high	- Check mains voltage
1055	Sewing motor	Overload	- Sewing motor (blocked/ rough running) - Control	- Check sewing motor - Check control
1056	Sewing motor	Excess temperature	- Sewing motor (rough running) - Control	- Check sewing motor - Check control
1058	Sewing motor	Speed	- Sewing motor	- Check sewing motor
1059	Sewing motor	Standstill- monitoring	- Sewing motor - Reference switch	- Check sewing motor - Check reference switch
1120	Sewing motor	Initialization	- Sewing motor - Sewing motor cable - Reference switch	- Check sewing motor - Check sewing motor cable - Check reference switch
1205	Sewing motor	Not in UDC (Upper Dead Center)	- Sewing motor - Sewing motor cable - Reference switch	- Switch machine off/on - Check sewing motor - Check sewing motor cable - Check reference switch
1301	Sewing motor	Referencing timeout	- Reference switch - Sewing motor - Control	- Check reference switch - Check sewing motor - Check control
1302	Sewing motor	Current feed error	- Sewing motor - Sewing motor cable - Control	- Check sewing motor - Check sewing motor cable - Check control
1310	Sewing motor	Communication- problem	- Sewing motor - Sewing motor cable - Reference switch	- Check sewing motor - Check sewing motor cable - Check reference switch
1320	Sewing motor	General sewing motor error	- Sewing motor - Sewing motor cable - Reference switch	- Check sewing motor - Check sewing motor cable - Check reference switch
2101	Step motor x-axis	Referencing timeout	- Reference switch - Step motor - Control	- Check reference switch - Check step motor - Check control
2152	Step motor x-axis	Overcurrent	- Step motor - Control	- Check step motor - Check control
2153	Step motor x-axis	Overvoltage	- Step motor - Control	- Check step motor - Check control
2155	Step motor x-axis	Overload	- Step motor - Control	- Check step motor - Check control
2156	Step motor x-axis	Excess temperature	- Step motor - Control	- Check step motor - Check control

Number	Error position	Description	Cause	Error elimination
2158	Step motor x-axis	Speed	- Step motor - Control	- Check step motor - Check control
2201	Step motor y-axis	Referencing timeout	- Reference switch - Step motor - Control	- Check reference switch - Check step motor - Check control
2252	Step motor y-axis	Overcurrent	- Step motor - Control	- Check step motor - Check control
2253	Step motor y-axis	Overvoltage	- Step motor - Control	- Check step motor - Check control
2255	Step motor y-axis	Overload	- Step motor - Control	- Check step motor - Check control
2256	Step motor y-axis	Excess temperature	- Step motor - Control	- Check step motor - Check control
2258	Step motor y-axis	Speed	- Step motor - Control	- Check step motor - Check control
2901	Step motor x+y-axis	Referencing: Timeout	- Reference switch - Step motor - Control	- Check all reference switches of the SM - Check step motor - Check control
3100	Machine	Control voltage-error	- Mains voltage-drop (momentary)	- Check mains supply
3101	Machine	Electrical power-error	- Mains voltage-drop (momentary)	- Check mains supply
3102	Machine	Intermediate circuit voltage error sewing motor	- Mains voltage-drop (temporary)	- Check mains supply - Check control
3103	Machine	Intermediate circuit voltage error step motor	- Mains voltage-drop (temporary)	- Check mains supply - Check control
3107	Machine	Excess temperature DAC III (>80°)	Control ventilation grill blocked or dirty	Clear or clean ventilation grill
3121	Machine	Pressure monitor pressure less	- Compressed air supply - Pressure monitor	- Check pressure - Check the el. connect.
3210	Machine	Upper thread breakage		Re-thread the machine
3215	Machine	Hook thread counter ran out		Fit in a new hook thread bobbin
4102	Operation	Exceeding the sewing limits	e.g. cut length longer than sew. basket length	- Correct value
4301	Memo-Dongle	Missing	- Memo Dongle missing - Memo Dongle broken	Insert Memo-Dongle
4303	Memo-Dongle	Empty	Memo-Dongle contains no data	

Number	Error position	Description	Cause	Error elimination
4304	Memo-Dongle	Wrong type	Boot-Dongle is inserted	Use Memo-Dongle
4307	Memo-Dongle	Wrong class	Dongle of the wrong class was inserted	Insert correct Dongle Format the Dongle
5101	Contour data-administration	EEPROM not initialized	- Control - Control contains no machine program	- Check control - Install machine program
5104	Contour data-administration	Checksum error	- Control	The machine resets itself automatically. Inform DA-Service
5301	Contour data-administration	Data memory full	Too many stitches in contour	Reduce number of stitches Inform DA-Service
5303	Contour data-administration	Data memory-overflow	Too many stitches in contour	Reduce number of stitches Inform DA-Service
5305	Contour data-administration	Invalid data storage attempt	Too many stitches in contour	Reduce number of stitches Inform DA-Service
5306	Contour data-administration	Invalid data request		Carry out buttonhole contour reset Inform DA-Service
5315	Contour data-administration	General error		Carry out buttonhole contour reset Inform DA-Service
6151-6952	I ² C/ CPU/ Mem-Manager		Fault	Switch machine off and then on again Inform DA-Service
7251-7659	ASC/ SSC/ RS485		Fault	Switch machine off and then on again Inform DA-Service
8151-8351	IDMA/ Xilinx/ Test pins		Fault (8151-8159: only an entry in the event memory – no further impairment)	Switch machine off and then on again Inform DA-Service

9. Maintenance

9.1 Cleaning and inspection

Check air pressure and adjust

- The operating pressure is 6 bar.
 - Turn screw 1 to adjust pressure
- Reduce pressure:** Turn screw 1 anti-clockwise.
Increase pressure: Turn screw 1 clockwise.

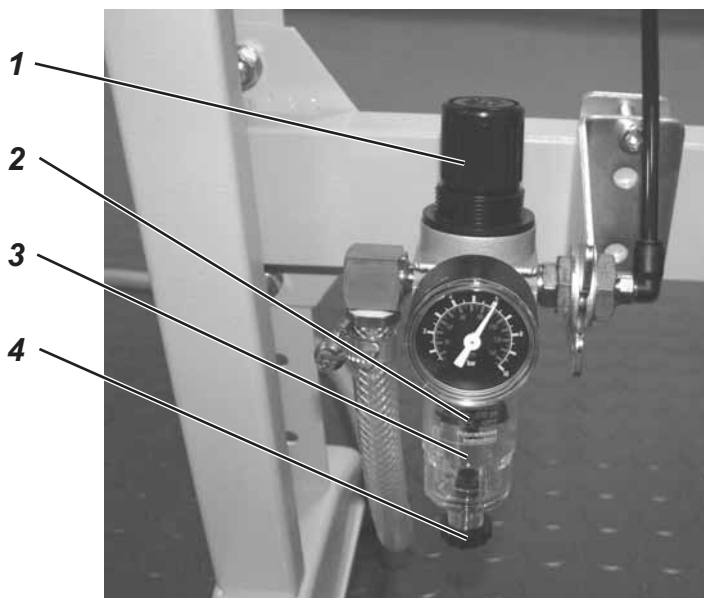

Scheduled maintenance	Explanation	Operating hours
Machine head Remove sewing dust, thread rests and cutting waste.	Places to be cleaned particularly: - Beneath the throat plate - Sewing basket - Area under the hook - bobbin housing - thread cutter	8
Pneumatic system Check or set air pressure		8
Check water level in the pressure regulator.	Water level must not rise to the level of the filter element 2 . Screw in drain screw 4 and blow out the water under pressure.	40
Clean filter	Through the filter element 2 condensation water and dirt are expelled. Cut off the machine from the air pressure system. Screw in drain screw 4 . The pneumatic system of the machine must be without pressure. Unscrew water trap 3 . Unscrew the filter element 2 and wash out the dirty filter housing and filter element with benzene (not a solvent!) and blow dry. Reassemble the maintenance unit and reconnect.	500
Check tightness of systems		500

9.2 Oil lubrication



Caution: Danger of injury !

Oil can cause skin eruption.
Avoid protracted contact with the skin.
In the event of contact, thoroughly wash the affected area.



ATTENTION !

The handling and disposal of mineral oils is subject to legal regulations.
Deliver used oil to an authorized collecting station.
Protect your environment.
Take care not to spill oil.

Check regularly the oil level in both of the supply containers 1 and 2.
The oil level should not drop below the mark “**min**” on the glass inspection!

Fill up the oil reservoirs exclusively with lubricating oil **DA-10** or an equivalent oil with the following specification:

- Viscosity at 40°C: 10 mm²/s
- Ignition point: 150°C

DA-10 oil can be bought at the sales points of **DÜRKOPP ADLER AG** under the following parts numbers:

250-ml-Container:	9047 000011
1-Litre-Container:	9047 000012
2-Litre-Container:	9047 000013
5-Litre-Container:	9047 000014

Refilling oil supply containers

- Refill the oil supply containers 1 and 2 through the hole in the glass inspection holes.
- The oil level has to be above the “**min**” mark.
Do not fill the oil supply containers beyond the “**max**” mark.

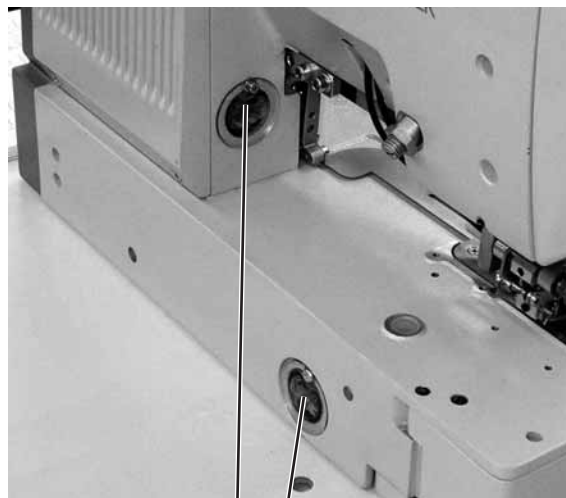

1 2

Notes: