



610-10/630-10

Operating Instructions



IMPORTANT
READ CAREFULLY BEFORE USE
KEEP FOR FUTURE REFERENCE

All rights reserved.

Property of Dürkopp Adler GmbH and protected by copyright. Any reuse of these contents, including extracts, is prohibited without the prior written approval of Dürkopp Adler GmbH.

Copyright © Dürkopp Adler GmbH 2023

1	About these instructions	5
1.1	For whom are these instructions intended?	5
1.2	Representation conventions – symbols and characters	5
1.3	Other documents	7
1.4	Liability	7
2	Safety	9
2.1	Basic safety instructions	9
2.2	Signal words and symbols used in warnings	10
3	Machine description	15
3.1	Overview of machine components	15
3.2	Declaration of Conformity	16
3.3	Proper use	16
4	Operation	19
4.1	Preparing the machine for operation	19
4.2	Switching on and off the machine	20
4.3	Changing the needle	21
4.4	Threading the needle thread	23
4.5	Threading the looper thread	25
4.6	Threading the reinforcement tape (610-10 only)	28
4.7	Adjusting thread tension and thread quantity for the seam pattern	31
4.7.1	Seam types and seam pattern	31
4.7.2	Adjusting the thread tension	31
4.7.3	Adjusting the needle thread quantity	31
4.7.4	Adjusting the looper thread quantity	32
4.8	Setting the sewing foot pressure	32
4.9	Lifting sewing foot	35
4.10	Locking the sewing foot in place in top dead center	37
4.11	Tilting and re-erecting the machine head	38
4.12	Switching the sewing lamp on and off	39
4.13	Sewing	40
5	Settings via software	43
5.1	Basic operation	43
5.1.1	Input of numeric values	44
5.1.2	Inputting text	46
5.2	Controller operating modes	48
5.3	Operating mode MAN	49
5.3.1	Parameters that can be set	50
5.3.2	Sewing process	53
5.4	Operating mode AUTO	54

5.4.1	Parameters that can be set	55
5.4.2	Sewing process	61
5.5	Operating mode EDIT	63
5.5.1	Parameters that can be set	64
5.5.2	Creating a new sewing program (PROGRAMMING)	69
5.5.3	Copying the sewing program	79
5.5.4	Deleting the sewing program	79
5.5.5	Length correction (LENGTH CORRECTION)	79
5.6	Displaying software version	81
5.7	Operating mode SERVICE	81
6	Maintenance	83
6.1	Cleaning	84
6.2	Lubricating	86
6.3	Servicing the pneumatic system	90
6.3.1	Setting operating pressure	90
6.3.2	Draining the water condensation	91
6.3.3	Cleaning the filter element	93
7	Setup	95
7.1	Checking the scope of delivery	95
7.2	Removing the transport locks	95
7.3	Assembling the stand	96
7.4	Tabletop	96
7.4.1	Assembling the controller	97
7.4.2	Assembling thread reel holder	98
7.5	Setting the working height	100
7.6	Adjusting the pedal	101
7.7	Electrical connection	103
7.7.1	Connecting the controller	104
7.7.2	Establishing equipotential bonding	105
7.8	Pneumatic connection	105
7.8.1	Connecting the compressed air maintenance unit	106
7.8.2	Setting operating pressure	106
7.9	Carrying out a test run	108
8	Decommissioning	109
9	Packing, transportation	111
10	Disposal	113
11	Troubleshooting	115
11.1	Customer Service	115
11.2	Messages of the software	115

11.3	Errors in sewing process	132
12	Technical data	135
13	Appendix	137

1 About these instructions



These instructions have been prepared with utmost care. They contain information and notes intended to ensure long-term and reliable operation.

Should you notice any discrepancies or if you have improvement requests, then we would be glad to receive your feedback through **Customer Service** ( p. 115).

Consider the instructions part of the product and store them in a place where they are readily available.

1.1 For whom are these instructions intended?

These instructions are intended for:

- **Operators:**
This group is familiar with the machine and has access to the instructions. Specifically, chapter **Operation** ( p. 19) is important for the operators.
- **Specialists:**
This group has the appropriate technical training for performing maintenance or repairing malfunctions. Specifically, the chapter **Setup** ( p. 95) is important for specialists.

Service Instructions are supplied separately.

With regard to minimum qualification and other requirements to be met by personnel, please also follow the chapter **Safety** ( p. 9).

1.2 Representation conventions – symbols and characters

Various information in these instructions is represented or highlighted by the following characters in order to facilitate easy and quick understanding:



Proper setting

Specifies proper setting.

**Disturbances**

Specifies the disturbances that can occur due to an incorrect setting.

**Cover**

Specifies which covers must be removed in order to access the components to be set.

**Steps to be performed when operating the machine
(sewing and equipping)****Steps to be performed for service, maintenance, and
installation****Steps to be performed via the software control panel****The individual steps are numbered:**

- 1st First step
- 2nd Second step
- etc. The steps must always be followed in the specified order.
- Lists are marked by bullet points.

**Result of performing an operation**

Change to the machine or on the display/control panel.

**Important**

Special attention must be paid to this point when performing a step.

**Information**

Additional information, e.g. on alternative operating options.

**Order**

Specifies the work to be performed before or after a setting.

References

 Reference to another section in these instructions.

Safety Important warnings for the machine users are specially designated. Since safety is of particular importance, hazard symbols, levels of danger and their signal words are described separately in the chapter **Safety** ( p. 9).

Orientation If no other clear location information is used in a figure, indications of **right** or **left** are always from the operator's point of view.

1.3 Other documents

The machine includes components from other manufacturers. Each manufacturer has performed a hazard assessment for these purchased parts and confirmed their design compliance with applicable European and national regulations. The proper use of these components is described in each manufacturer's instructions.

1.4 Liability

All information and notes in these instructions have been compiled in accordance with the latest technology and the applicable standards and regulations.

Dürkopp Adler cannot be held liable for any damage resulting from:

- Breakage and damage during transport
- Failure to observe these instructions
- Improper use
- Unauthorized modifications to the machine
- Use of untrained personnel
- Use of unapproved parts

Transport

Dürkopp Adler cannot be held liable for breakage and transport damages. Inspect the delivery immediately upon receiving it. Report any damage to the last transport manager. This applies even if the packaging is undamaged.

Leave machines, equipment and packaging material in the condition in which they were found when the damage was discovered. This will ensure any claims against the transport company.

Report all other complaints to Dürkopp Adler immediately after receiving the product.

2 Safety

This chapter contains basic information for your safety. Read the instructions carefully before setting up or operating the machine. Always follow the information included in the safety instructions. Failure to do so can result in serious injury and property damage.



2.1 Basic safety instructions

The machine may only be used as described in these instructions. The instructions should be available at the machine's location at all times.

Work on live components and equipment is prohibited. Exceptions are defined in the DIN VDE 0105.

For the following work, switch off the machine at the main switch or disconnect the power plug:

- Replacing the needle or other sewing tools
- Leaving the workstation
- Performing maintenance work and repairs
- Threading

Missing or faulty spare parts could impair safety and damage the machine. Only use original parts from the manufacturer.

Transport Use a sturdy lifting carriage or forklift truck for transporting the machine. Raise the machine max. 20 mm and secure it to prevent it from slipping off.

Setup The power cable must have a plug that is authorized for use in the country in which the machine is being used. The power plug may only be assembled to the power cable by qualified specialists.

Obligations of the operator Follow the country-specific safety and accident prevention regulations and the legal regulations concerning industrial safety and the protection of the environment.

All the warnings and safety signs on the machine must always be in legible condition. Do not remove!
Missing or damaged warnings and safety signs must be replaced immediately.

Requirements to be met by the personnel

Only qualified specialists may:

- set up the machine
- carry out maintenance work and repairs
- carry out work on electrical equipment

Only authorized persons may work on the machine and they must first have understood these instructions.

Operation

Inspect the machine while in use for any externally visible damage. Stop working if you notice any changes to the machine. Report any changes to your supervisor. Do not use a damaged machine any further.

Safety equipment

Safety equipment should not be removed or deactivated. If it is essential to remove or deactivate safety equipment for a repair operation, it must be assembled and put back into service immediately afterward.

2.2 Signal words and symbols used in warnings





Warnings in the text are distinguished by color bars. The color scheme based on the severity of the danger. Signal words indicate the severity of the danger.

Signal words Signal words and the hazard they describe:

Signal word	Meaning
DANGER	(with hazard symbol) If ignored, fatal or serious injury will result
WARNING	(with hazard symbol) If ignored, fatal or serious injury can result

CAUTION	(with hazard symbol) If ignored, moderate or minor injury can result
CAUTION	(with hazard symbol) If ignored, environmental damage can result
NOTICE	(without hazard symbol) If ignored, property damage can result

Symbols The following symbols indicate the type of danger to personnel:

Symbol	Type of danger
	General
	Electric shock
	Puncture
	Crushing
	Environmental damage

Examples Examples of the layout of warnings in the text:

DANGER



Type and source of danger!

Consequences of non-compliance.

Measures for avoiding the danger.

↪ This is what a warning looks like for a hazard that will result in serious injury or even death if ignored.

WARNING



Type and source of danger!

Consequences of non-compliance.

Measures for avoiding the danger.

↪ This is what a warning looks like for a hazard that could result in serious or even fatal injury if ignored.

CAUTION



Type and source of danger!

Consequences of non-compliance.

Measures for avoiding the danger.

↪ This is what a warning looks like for a hazard that could result in moderate or minor injury if the warning is ignored.

NOTICE

Type and source of danger!

Consequences of non-compliance.

Measures for avoiding the danger.

- ↪ This is what a warning looks like for a hazard that could result in property damage if ignored.

CAUTION



Type and source of danger!

Consequences of non-compliance.

Measures for avoiding the danger.

- ↪ This is what a warning looks like for a hazard that could result in environmental damage if ignored.

3 Machine description

3.1 Overview of machine components

Fig. 1: Overview of machine components

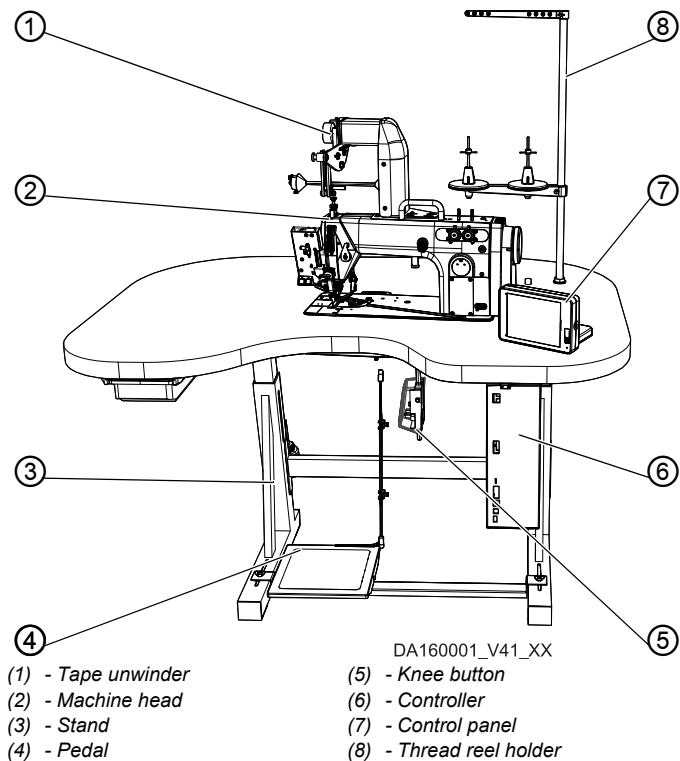

3.2 Declaration of Conformity

The machine complies with European regulations ensuring health, safety, and environmental protection as specified in the declaration of conformity or in the declaration of incorporation.



3.3 Proper use

Class 610-10

The machine has been designed for smooth sewing / sewing fullness into the upper and/or lower material layer.

The machine has been optimized for the programmed pre-ruffling of sleeves (sleeve crown) and programmed taping operations on armholes, neck openings, etc. based on a gradation logic.

Class 630-10

The machine has been designed for smooth sewing / sewing fullness into the upper and/or lower material layer.

The machine has been optimized for the programmed pre-ruffling of sleeves (sleeve crown) based on a gradation logic.

General

The machine is intended only for use with dry sewing material. The sewing material must not contain any hard objects.

The needle thicknesses permissible for the machine are listed in the **Technical Data** (📖 p. 135) chapter.

The seam must be completed with a thread that satisfies the requirements of the specific application at hand.

The machine is intended for industrial use.

The machine may only be set up and operated in dry conditions on well-maintained premises. If the machine is operated on premises that are not dry and well-maintained, then further measures may be required which must be compatible with DIN EN 60204-31.

Only authorized persons may work on the machine.

Dürkopp Adler cannot be held liable for damages resulting from improper use.

WARNING



Risk of injury from live, moving and cutting parts as well as from sharp parts!

Improper use can result in electric shock, crushing, cutting and punctures.

Follow all instructions provided.

NOTICE

Property damage from non-observance!

Improper use can result in material damage at the machine.

Follow all instructions provided.

4 Operation

The operating sequence consists of several different steps. Fault-free operation is necessary in order to achieve a good sewing result.

4.1 Preparing the machine for operation

WARNING



Risk of injury from moving parts, cutting and sharp parts!

Crushing, cutting and punctures are possible.

If possible, make preparations only when the machine is switched off.

Complete the following steps in preparation of sewing before starting to work:

- Changing the needle
- Threading the needle thread
- Threading the looper thread
- Threading the reinforcement tape (610-10 only)
- Adjusting the thread tension

4.2 Switching on and off the machine

Once the pneumatic connection (📖 p. 105) has been established, the machine can be switched on and off using the main switch on the controller.

Fig. 2: Switching on and off the machine

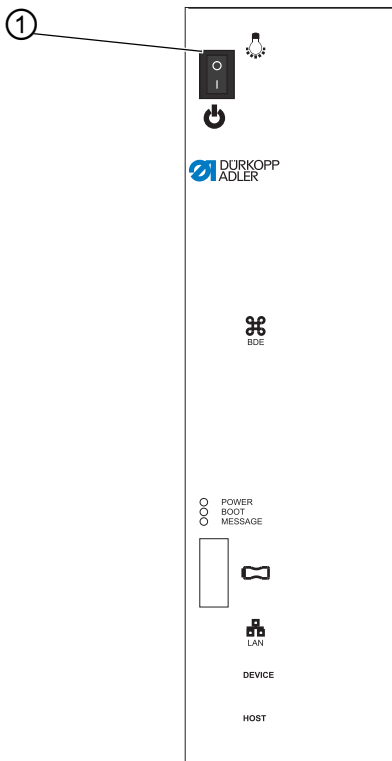

(1) - Main switch

DA150012_V41_XX

Switching on the power supply

To switch on the machine:



1. Press the main switch (1) down to position I.
 - ↳ POWER LED illuminates, MESSAGE LED flashes briefly.
 - ↳ The splash screen appears on the display:
 - On the left, the class
 - On the right, the firmware
 - ↳ You can hear the air being released onto the moving parts. The machine performs a reference run and is ready for sewing when the display shows the start screen. The controller starts in the operating mode that was active when it was switched off - **MAN** or **AUTO**.

Switching off the power supply

To switch off the machine:



1. Press the main switch (1) up to position 0.
 - ↳ The control panel shuts down. When the POWER LED goes out, the machine and the controller are disconnected from the power supply.

4.3 Changing the needle



Order

After switching to needles with a thickness of 100 or greater, have the needle evasive movement of the looper (ellipsis width) adjusted by qualified specialists. For the proper setting, refer to the  Service Instructions.

Fig. 3: Inserting and replacing the needle



To change the needle:

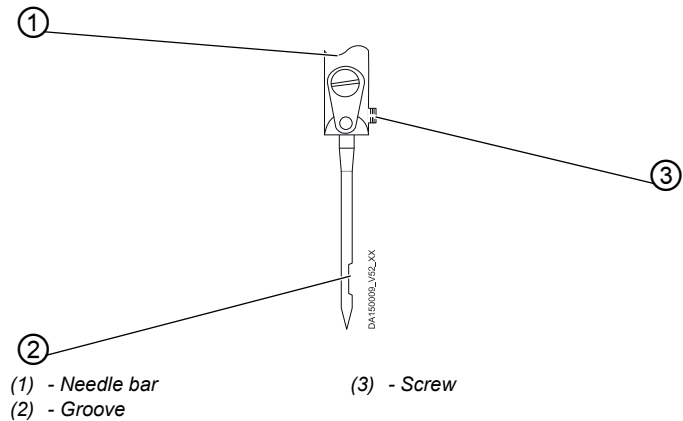

1. Turn the handwheel until the needle bar (1) reaches the upper end position.
2. Loosen the screw (3).
3. Pull the needle out towards the bottom.
4. Insert the new needle.



Important

Align the needle in such a way that the groove (2) is pointing to the rear.

5. Tighten the screw (3).

4.4 Threading the needle thread

Fig. 4: Threading the needle thread (1)

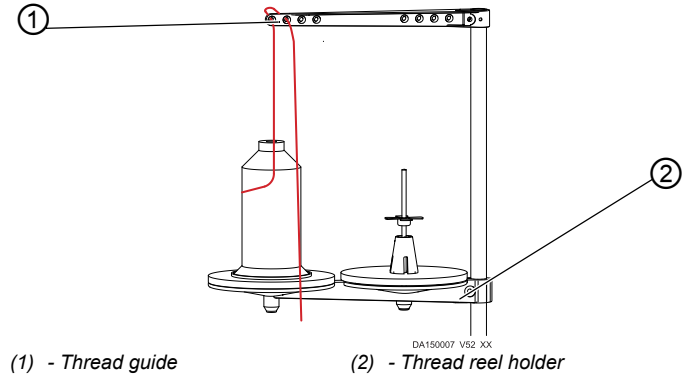

To thread the needle thread:



1. Fitting the thread reel onto the left plate of the thread reel holder (2).
2. Feed the thread from the front to the rear through the 1st hole on the front. Feed the thread from the rear to the front through the next hole.



Important

The thread guide (1) must be positioned vertically above the thread reel holder (2).

Fig. 5: Threading the needle thread (2)

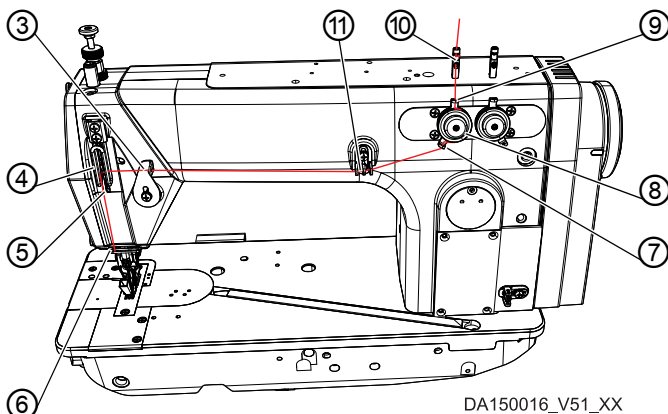

- | | |
|------------------------|---------------------------------------|
| (3) - Diverter | (8) - Needle thread tensioner element |
| (4) - Thread regulator | (9) - Thread guide |
| (5) - Thread lever | (10) - Thread guide |
| (6) - Thread guide | (11) - Thread advancing device |
| (7) - Thread guide | |

3. Feed the thread from top to bottom through the thread guide (10).
4. Feed the thread to the rear side of the thread guide (10) before threading it from rear to front through the lower hole.
5. Feed the thread from top to bottom through the thread guide (9) on the needle thread tensioner element (8).
6. Feed the thread clockwise around the needle thread tensioner element (8).



Important

The thread must always be fed around the appropriate tension disk in such a way that it follows the longer path from thread guide (9) to thread guide (7).

7. Insert the thread through the thread guide (7).
8. Insert the thread from the right to the left through the thread advancing device (11).
9. Feed the thread from the right to the left through the diverter (3).
10. Feed the thread from right to left through the thread regulator (4) and the thread lever (5):



Important

Pay attention to thread tension (📖 p. 31) and thread quantity!

11. Feed the thread from top to bottom through the thread guide (6) on the machine head.

Fig. 6: Threading the needle thread (3)

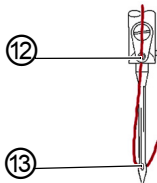

(12) - Thread guide needle bar

(13) - Needle eye

12. Feed the thread from top to bottom rear through the thread guide (13) on the needle bar.

13. Run the thread through the needle eye (14) from front to rear.

4.5 Threading the looper thread

Fig. 7: Threading the looper thread (1)

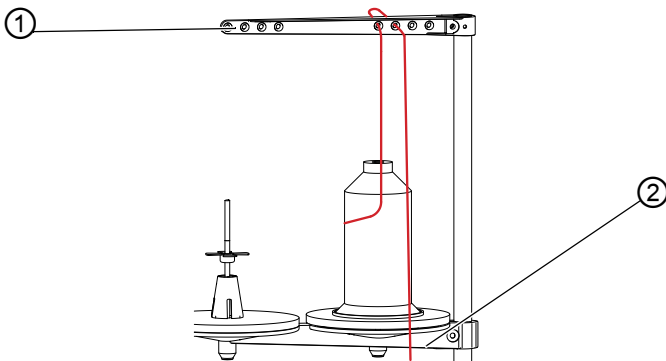

(1) - Thread guide

(2) - Thread reel holder

To thread the looper thread:



1. Slip the thread reel onto the right plate of the thread reel holder (2).

2. Feed the thread from the front to the rear through the 1st hole on the rear. Feed the thread from the rear to the front through the next hole.

Fig. 8: Threading the looper thread (2)

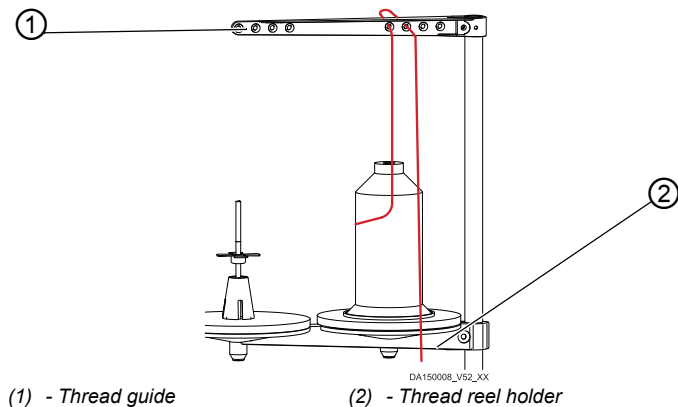

Important

The thread guide (1) must be positioned vertically above the thread reel holder (2).

Fig. 9: Threading the looper thread (3)

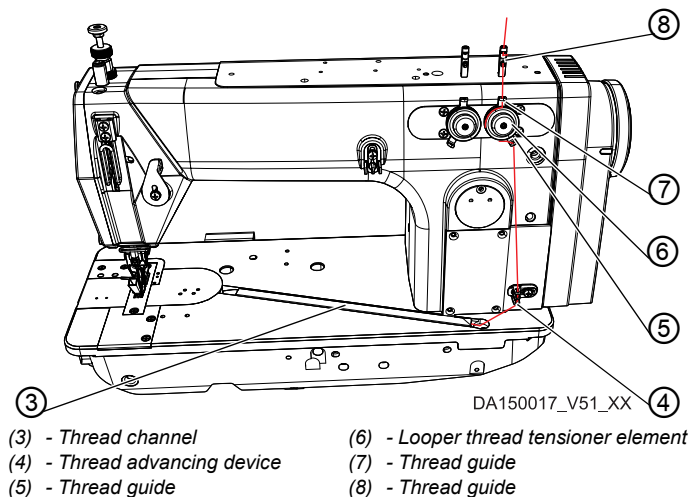

3. Feed the thread from top to bottom through the thread guide (8).
4. Feed the thread to the rear side of the thread guide (8) before threading it from rear to front through the lower hole
5. Feed the thread from top to bottom through the thread guide (7) on the looper thread tensioner element (6).
6. Feed the thread counterclockwise around the looper thread tensioner element (6).



Important

The thread must always be fed around the appropriate tension disk in such a way that it follows the longer path from thread guide (7) to thread guide (5).

7. Feed the thread from top to bottom through the thread advancing device (4).
8. Insert the thread through the thread guide of the thread channel (3). Proceed by pulling the thread from the rear under the covering plate of the thread channel.

Fig. 10: Threading the looper thread (4)

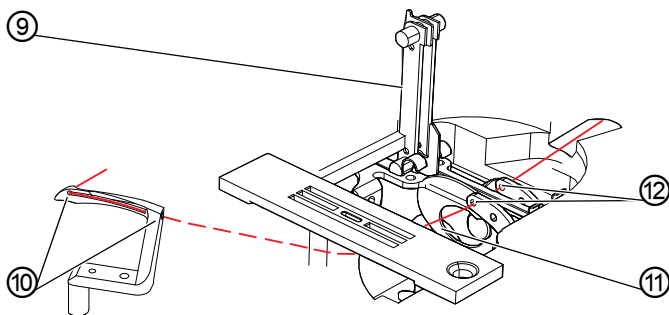

DA150023_V51_XX

- | | |
|-----------------------------------|-------------------------------------|
| (9) - Thread bobbin case retainer | (11) - Thread take-up disk |
| (10) - Looper holes | (12) - Holes in looper thread guide |

9. Remove the cover plates to the right and left of the throat plate.
10. Lift the thread bobbin case retainer (9) from its latching.
11. Turn the handwheel to position D in such a way that the thread take-up disk (11) is adjusted accordingly.
12. Insert the thread from the right to the left through the holes (12) of the looper thread guide.

13. Turn the handwheel until the looper hole (10) is accessible.
14. Insert the thread from the right to the left through the looper holes (10) before pulling it out by approx. 3 cm.
15. Press down and lock into place the thread bobbin case retainer (9).
16. Insert the covering plates of the throat plate on the right and the left.

4.6 Threading the reinforcement tape (610-10 only)



Proper setting

Facing the head cover, the reel of reinforcement tape must rotate clockwise when unwinding.

Fig. 11: Threading the reinforcement tape (1)

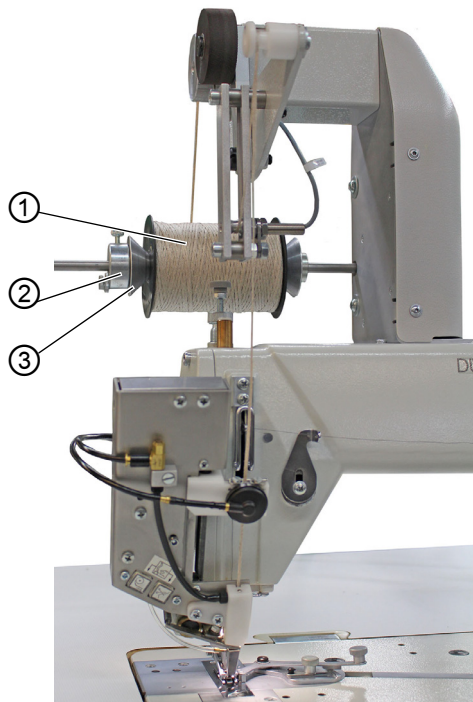

- (1) - Reel of reinforcement tape (3) - Counter bearing
(2) - Reel holder

To thread the reinforcement tape:



1. Place the reel of reinforcement tape (1) onto the reel holder (2) and lock it in place using the counter bearing (3). While doing so, make sure the counter bearing (3) is pressed against the reel of reinforcement tape (1).

Fig. 12: Threading the reinforcement tape (2)

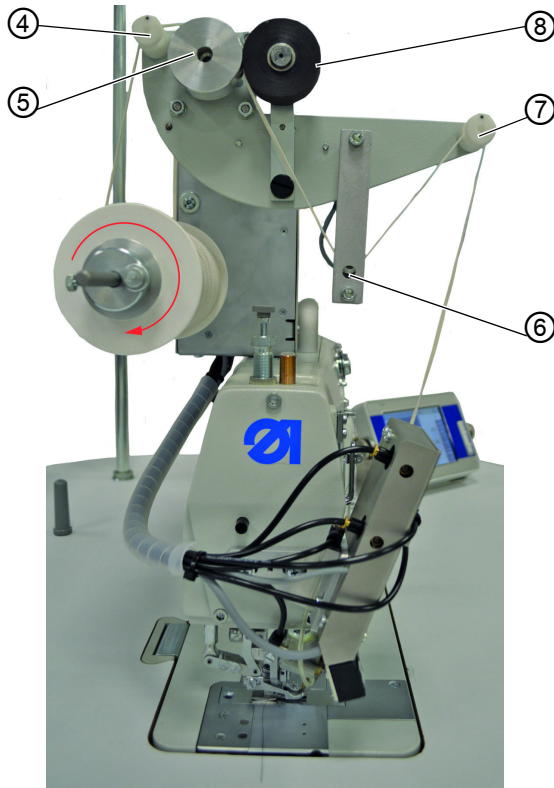

- (4) - Guide
- (5) - Transport roller
- (6) - Sensor transducer

- (7) - Guide
- (8) - Pressure roller

2. Insert the reinforcement tape through the guide (4).
3. Feed the tape between transport roller (5) and spring-loaded pressure roller (8).
4. Feed the tape through underneath the sensor transducer (6).
5. Insert the reinforcement tape through the guide (7).

Fig. 13: Threading the reinforcement tape (3)

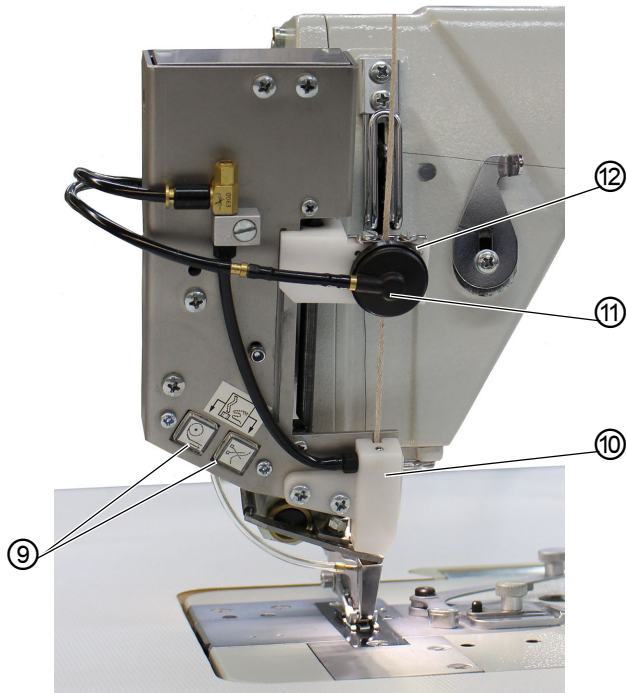

(9) - Push buttons
(10) - Guide piece

(11) - Tape clamp
(12) - Guide

6. Activate threading mode by pressing the two push buttons (9) on the machine at the same time.
 - ↳ The tape clamp is released, making compressed air available in the guide piece (10) for the transport of the reinforcement tape.
7. Insert the reinforcement tape through the guide (12).
8. Set the guide (12) approximately to the width of the reinforcement tape used.
9. Insert the reinforcement tape through the tape clamp (11).
10. Insert the reinforcement tape into the guide piece (10) and allow it to run through until no excess reinforcement tape is left between the tape clamp (11) and the guide piece (10). Grab the reinforcement tape, using, for example, a pair of tweezers while holding on to the end.

11. End threading mode by pressing the two push buttons (9) on the machine.

↳ The reinforcement tape is cut off at the lower end of the guide piece (10).



Important

If the cut strip of reinforcement tape is too short, this strip can be pulled into the tulle foot and prevent the reinforcement tape from being transported.

4.7 Adjusting thread tension and thread quantity for the seam pattern

4.7.1 Seam types and seam pattern

To achieve the desired seam pattern, you need to adjust both the thread tension and the thread quantity necessary for the stitch formation for the needle thread and the looper thread.

The seam types fall into 3 different categories:

- Tight seam
- Normal seam
- Loose seam (highly elastic)

4.7.2 Adjusting the thread tension



Proper setting

The needle thread tension must be tighter than the looper thread tension.



Disturbance from incorrectly set thread tension

- Too tight: Crimping of the sewing material
- Too loose: Missing stitches

Use the control panel (et sqq) to set the thread tension ( p. 50 f).

4.7.3 Adjusting the needle thread quantity

See  Service Instructions.

4.7.4 Adjusting the looper thread quantity

See  Service Instructions.

4.8 Setting the sewing foot pressure

You can use the adjusting wheel (1) and nut (2) on top of the sewing head to regulate the pressure the sewing feet exert on the sewing material. You have the option of adjusting center foot and top feed foot separately.



Proper setting

The sewing material does not slip and is correctly transported. The correct sewing foot pressure depends on the sewing material: (basic value: 26/47 mm).

Fig. 14: Setting the sewing foot pressure (1)

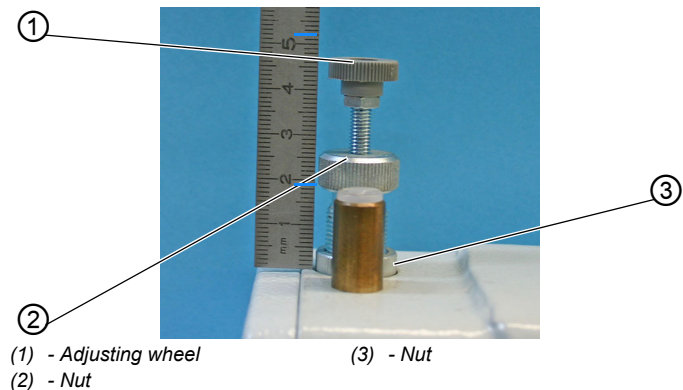

Disturbance from incorrectly set sewing foot pressure

- Excessively high sewing foot pressure:
Impressions on the sewing material, possibly ruffling of the sewing material
- Excessively low sewing foot pressure:
Slipping of the sewing material, stitch length too short

Fig. 15: Setting the sewing foot pressure (2)



(4) - Handwheel



Important

Do not adjust the sewing foot pressure of the center foot unless the feed dog pokes out of the throat plate or the handwheel (4) is in position E.

To adjust the sewing foot pressure of the center foot:



1. Loosen the nut (3).
2. Setting the sewing foot pressure:
 - Increase sewing foot pressure = turn the nut (2) clockwise.
 - Reduce sewing foot pressure = turn the nut (2) counter-clockwise.



Important

Hold the adjusting wheel (1) in place during the adjustment in order to prevent the pressure of the top feed foot from being altered inadvertently!

3. Re-tighten the nut (3).



Important

Do not adjust the sewing foot pressure of the top feed foot unless the top feed foot rests on the feed dog.

Fig. 16: Setting the sewing foot pressure (3)

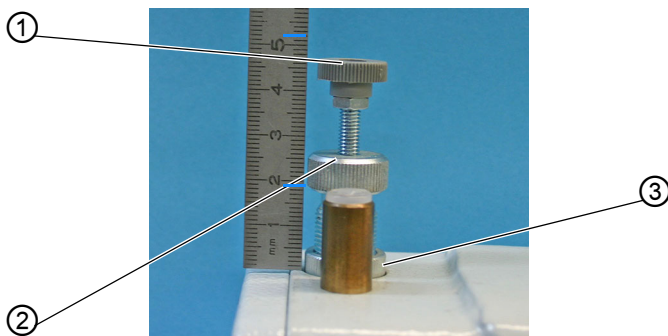

(1) - Adjusting wheel
(2) - Nut

(3) - Nut

To adjust the sewing foot pressure for the top feed foot:



1. Setting the sewing foot pressure:

- Increase sewing foot pressure = turn the adjusting wheel (1) clockwise
- Reduce sewing foot pressure = turn the adjusting wheel (1) counterclockwise

4.9 Lifting sewing foot

The sewing foot can be lifted electro-pneumatically using the pedal to insert or move the sewing material.

Fig. 17: Lift the sewing foot (1)

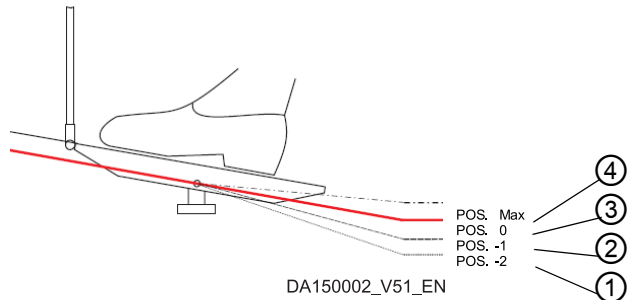

DA150002_V51_EN

- | | |
|--|---------------------|
| (1) - Sew stitch condensation and cut off thread | (3) - Rest position |
| (2) - Lift sewing foot | (4) - Sewing active |

To lift the sewing foot:



1. Press the pedal to position -1 (3).

☞ The sewing foot is raised and remains raised while the pedal is held in position.

To lift the sewing foot at the seam end:



1. Press the pedal to position -2 (4).

☞ The thread is cut, and the sewing foot is lifted.

Lower sewing foot

WARNING



Risk of injury from moving parts!

Crushing injuries may be sustained while lowering the sewing foot.

Do NOT put your hands under the lifted sewing foot.

Fig. 18: Lift the sewing foot (2)

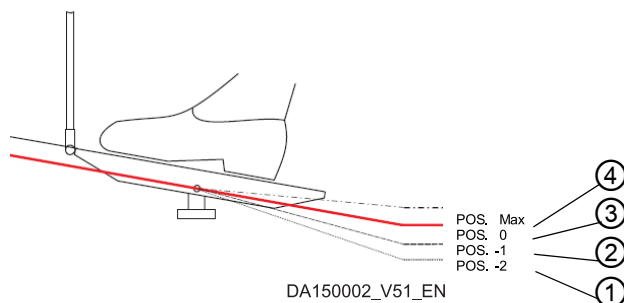

- | | |
|--|---------------------|
| (1) - Sew stitch condensation and cut off thread | (3) - Rest position |
| (2) - Lift sewing foot | (4) - Sewing active |

To lower the sewing foot:



1. Press the pedal to position 0.
- ↙ The sewing foot lowers.

4.10 Locking the sewing foot in place in top dead center

You can use the locking button (1) on the machine head to lock the lifted sewing foot in place in top dead center.

Fig. 19: Lock the sewing foot in top dead center

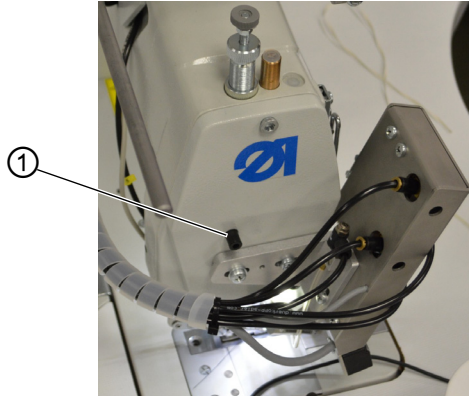

(1) - Locking button

To lock the sewing foot in place in top dead center:



1. Lift the sewing foot using the pedal ( p. 35).
 2. Press the locking button.
 3. Release the pedal.
- ✎ The sewing foot is locked in place in top dead center.

You can remove the lock by lowering the sewing foot ( p. 35).

4.11 Tilting and re-erecting the machine head

The machine head can be tilted for maintenance work.

Fig. 20: Tilting and re-erecting the machine head

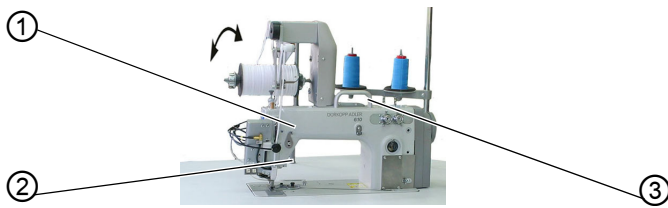

(1) - Machine head
(2) - Support

(3) - Handle

Tilting the machine head

To tilt the machine head:



1. Use the handle (3) to tilt the machine head (1) up to the support (2).

Erecting the machine head

To erect the machine head:



1. Carefully erect the machine head (1) using the handle (3).

4.12 Switching the sewing lamp on and off

The sewing lamp switches on and off independent of the main switch.

Fig. 21: Switching the sewing lamp on and off

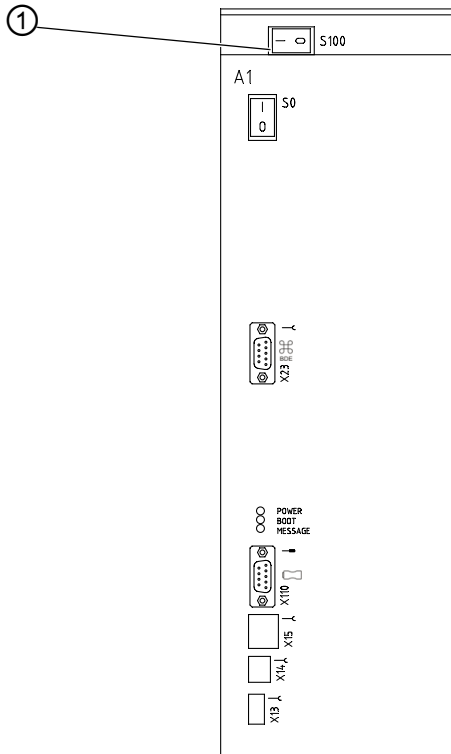

(1) - Switch

To switch on the sewing lamp:



1. Press switch (1) to the left to position I.

To switch off the sewing lamp:



1. Press switch (1) to the right to position 0.

4.13 Sewing

The pedal starts and controls the sewing process.

Fig. 22: Sewing

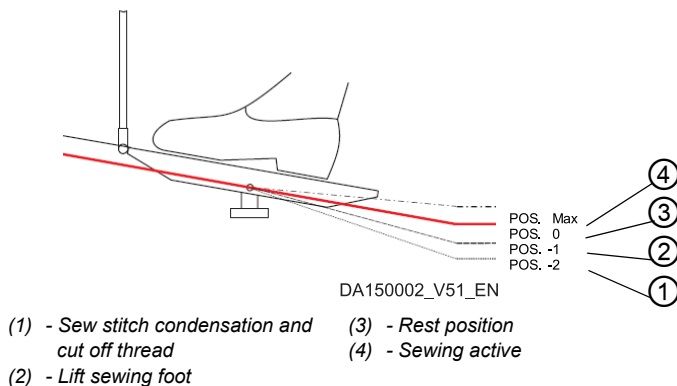

INITIAL POSITION

- Pedal to position 0 (3):
 - ↳ The machine is at a standstill.
Needle and sewing foot are up / down

To position the sewing material:



1. Press the pedal to position -1 (2).
 - ↳ The sewing foot is lifted.
2. Push the sewing material into the initial position.
3. Press the pedal to position 0 (3).
 - ↳ The sewing foot lowers onto the sewing material.

AT SEAM BEGINNING

Proceed as follows to start a seam:



1. Press the pedal (4) forward.
 - ↳ The machine sews. The speed increases the further forward the pedal is pressed.

WHEN SEWING

The speed increases the further forward the pedal is pressed:



1. Pedal in Position 0 (3).

↳ The machine stops.
Needle and sewing foot are up / down.

Proceed as follows to continue the seam:



1. Press the pedal (4) forward.

↳ The machine continues to sew.

AT THE END OF THE SEAM

Proceed as follows to end the seam:



1. Press the pedal to position -2 (1) and keep it there

↳ The thread is cut.
The machine stops.
Needle and sewing foot are raised.

2. Remove the sewing material.

5 Settings via software

5.1 Basic operation

All settings for the machine are performed using the **OP7000** control panel.

Fig. 23: Basic operation

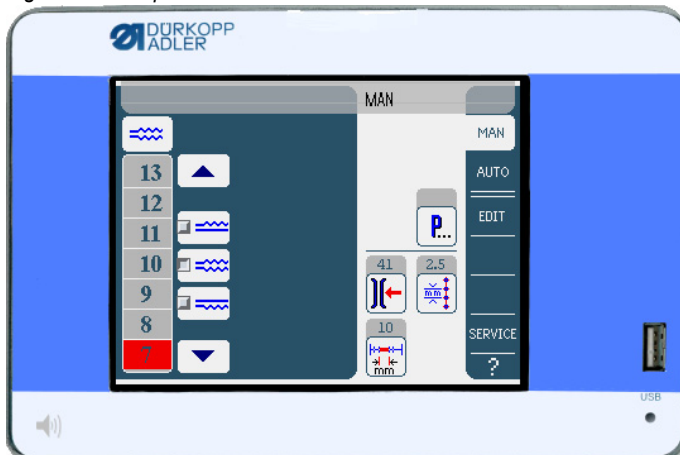

The activation of the sewing motor and the stepper motors is performed by the controller.

Up to 999 sewing programs can be saved.

Each sewing program can contain up to 30 sewing steps.

Each sewing step can be assigned various parameters such as stitch length, fullness values, thread tension, segment length etc.

The sewing programs are displayed continuously whilst sewing is in progress. Programs can be mirrored for the other side of the sewing material.

All functions and inputs are triggered by touching the screen.

Numeric values for the individual parameters and text for the program names can be input in the individual operating modes.

5.1.1 Input of numeric values



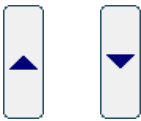



Fig. 24: Input of numeric values



The user interface for inputting numeric values consists of the following elements:

- **Header, consisting of:**
 - Symbol of the selected parameter
 - Name of the parameter
 - Value range of the parameter
 - Symbol for exiting the user interface
- **Input line for the value**
- **Keypad**

Meaning of the buttons

Symbols/buttons	Meaning
	Value input
	Change of plus/minus sign
	Input of a decimal point for values that permit places of decimals
	Changing the value incrementally up / down. Delete numerical value position from the input line
	Delete the input value
	Exit the user interface without inputting or saving any values
	Save the value that was input and exit the user interface

5.1.2 Inputting text



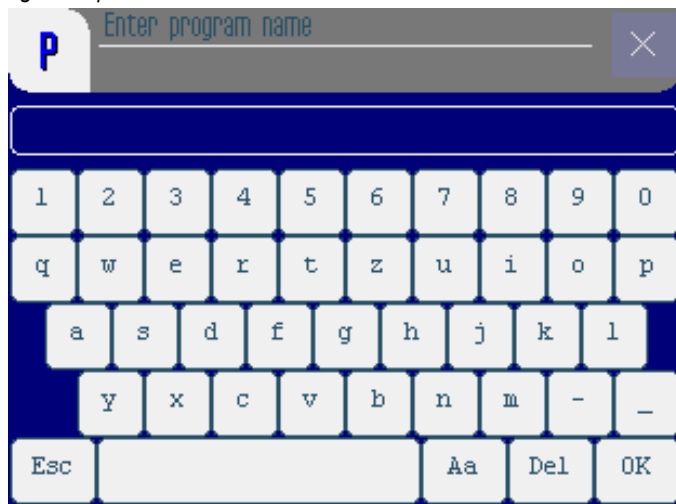

Fig. 25: Input of text









The user interface for inputting text consists of the following elements:

- **Header, consisting of:**
 - Symbol for new sewing program
 - Symbol for exiting the user interface
- **Input line for the text**
- **Keypad**

Meaning of the buttons

Symbols/buttons	Meaning
 	Input of numbers in the text
 	Input of text
	Input of a hyphen

Symbols/buttons	Meaning
	Input of a underscore
	Exit the user interface without inputting or saving any text
	Input of a space
	Switching between upper case/lower case
	Delete letters or digits from the input line
	Save the value that was input and exit the user interface

5.2 Controller operating modes

The controller offers 4 different operating modes:

- **MAN**

Manual mode allows you to sew without a sewing program, which is a useful option for performing tests and repairs.

Any changes made to parameters are applied immediately during the sewing process.

- **AUTO**

Automatic mode allows you to execute sewing programs.

The seams are divided into individual sewing steps within the sewing programs. Each step is assigned its own individual sewing parameters such as fullness etc.

- **EDIT**

You can use Edit mode to create (PROGRAMMING), modify, delete, copy (EDIT) and optimize (LENGTH CORRECTION) sewing programs.

- **SERVICE**

Service mode contains functions for use during service work.

Service mode is password-protected to avoid accidentally changing the machine settings.

5.3 Operating mode MAN

Fig. 26: Operating mode MAN

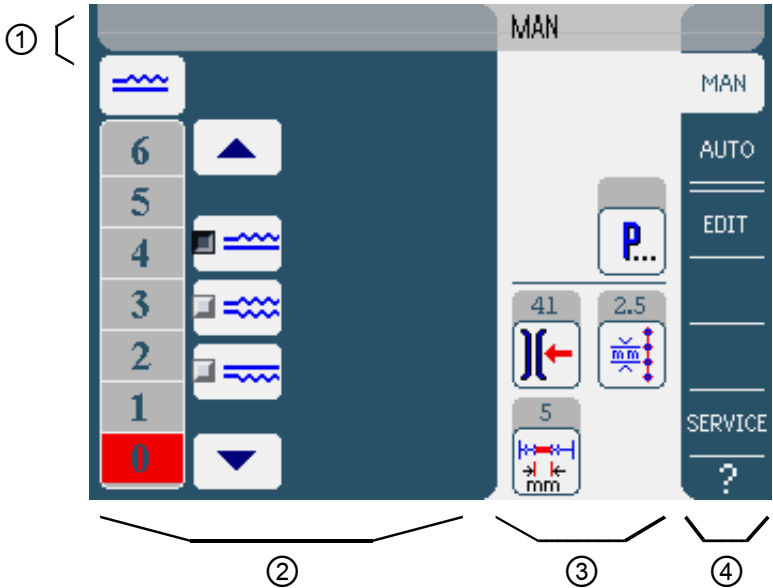

Header (1)

Operating mode **MAN** is displayed.

Left pane (2)

Buttons for manually inputting the fullness are displayed here.

Middle pane (3)

This pane holds the symbols of all parameters that can be set in







MAN operating mode as well as the display  of the path length already sewn in mm. The gray fields above the parameter symbols show the respective current values.

Right pane (4)

Another user interface or another operating mode can be selected here.

5.3.1 Parameters that can be set

The following table lists the parameters that can be set in **MAN** operating mode.

Symbols/buttons	Meaning
	Setting the fullness,  p. 51
	Inputting the needle thread tension
	Inputting the stitch length in mm
	Other program parameters in operating mode MAN ,  p. 51

To set a parameter:





1. Tap the desired button.
 The user interface for setting the desired parameter is displayed.

For some parameters the setting is more than just a numerical value. These parameters are described below.

Mode MAN Setting the fullness

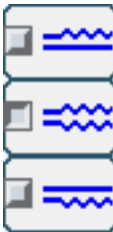

The following table lists the individual symbols and buttons for manually setting the fullness.

Symbols/buttons	Meaning
	Input the fullness. The fullness setting is displayed by a button highlighted in red.
	Select the type of fullness: <ul style="list-style-type: none"> • Top (top feed) • Lower (lower transport) • Top and bottom (differential top and bottom feed) The fullness selected is displayed in an activated control field.
	Display of further buttons for inputting the fullness. The buttons 0 to 16 are available for input.

To set the fullness:



1. Select the type of fullness.
 ↳ The type of fullness selected is displayed in an activated control field within the symbol.
2. If a higher or lower degree of fullness is required, use the arrows to display more buttons.
3. Input the fullness using the buttons **0** to **16**.

Mode MAN Other program parameters



A tap on the **Other program parameters** button will bring up an overview of all available parameters.

Fig. 27: Other program parameters in operating mode MAN

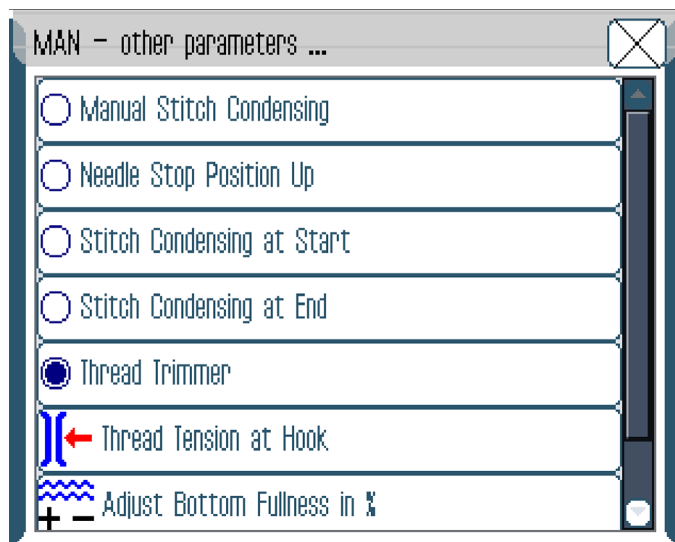

Parameter	Meaning	Value range
Manual Stitch Condensing	Manual stitch condensing	0 – 1
Needle Stop Position Up	Needle position up when sewing stops on (= 1) or off (= 0)	0 – 1
Stitch Condensing at Start	Stitch condensing at seam beginning on (= 1) or off (= 0)	0 – 1
Stitch Condensing at End	Stitch condensing at seam end on (= 1) or off (= 0)	0 – 1
Thread Trimmer	Thread trimmer on (= 1) or off (= 0)	0 – 1

Parameter	Meaning	Value range
Thread Tension at Hook	Looper thread tension	1 – 99
Adjust Bottom Fullness in %	Fullness correction parameter bottom (%)	-50 – 50
Adjust Flat Sewing in %	Flat sewing correction, only when sewing without fullness (%)	0 – 50

5.3.2 Sewing process

This is how you sew without fullness:



1. Set all fullness values to 0 ( p. 50).
2. Adopt or, if necessary, enter the values for needle thread tension and stitch length.
3. Press the pedal forward and sew.



- ↳ The length in mm sewn in the seam is displayed. When the thread is cut, the display is reset. When starting the next sewing process, the machine will start counting at 0.

This is how you sew with fullness:



1. Set the desired fullness ( p. 50).
2. Press the pedal forward and sew.



- ↳ The length in mm sewn in the seam is displayed. When the thread is cut, the display is reset. When starting the next sewing process, the machine will start counting at 0.

You can also change parameters while in the middle of a seam.

This is how you change parameters in the middle of a seam:



1. Press the pedal to position 0.
 2. Change the desired parameter on the control panel ( p. 50).
 3. Press the pedal forward again and sew.
- ↳ The seam will be sewn using the altered parameter value.

5.4 Operating mode AUTO

Fig. 28: Operating mode AUTO

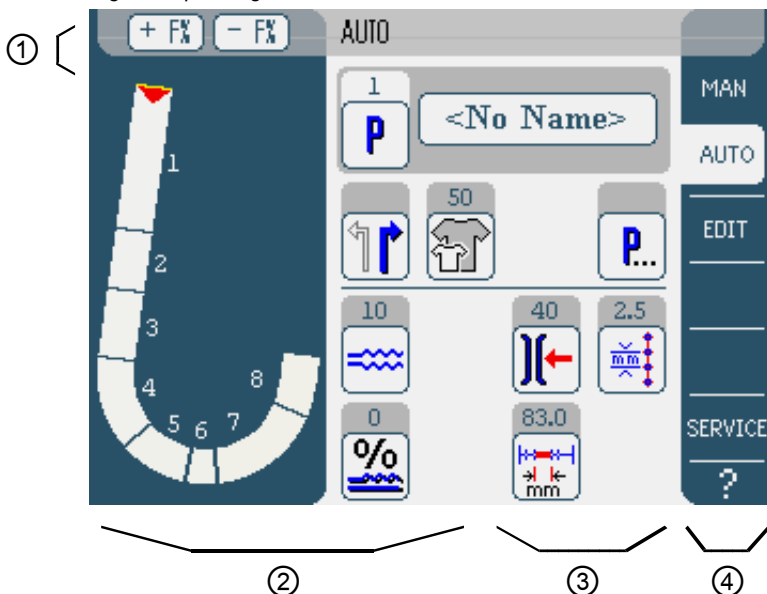

Header (1)

Operating mode **AUTO** is displayed. The buttons **+ F%** and **- F%** offer quick access for setting the fullness correction in %. The setting affects the fullness of the entire sewing program.

Left pane (2)

The graphical representation of the entire seam, divided into the number of programmed sewing steps, is displayed here. A red bar with an arrow indicates the direction of sewing and progress of the sewn seam.

Middle pane (3)

This pane holds the symbols of all parameters that can be set in













MAN operating mode as well as the display  of the path length already sewn in mm. The gray fields above the parameter symbols show the respective current values.

Right pane (4)

Another user interface or another operating mode can be selected here.

5.4.1 Parameters that can be set

The following table lists the parameters that can be set in **AUTO** operating mode.

Symbols/buttons	Meaning
	Program selection,  p. 56
	Select the right or left piece to be sewn
	Set the sewing material size,  p. 57
	Other program parameters in operating mode AUTO ,  p. 60
	Temporarily setting the fullness value until the next sewing step,  p. 58
	Applying a % correction to the fullness values of all sewing steps,  p. 59
	Setting the needle thread tension. If changed in AUTO operating mode, the value is permanently saved in the sewing program.

Symbols/buttons	Meaning
	Setting the stitch length in mm. If changed in AUTO operating mode, the value is permanently saved in the sewing program.

To set a parameter:



1. Tap the desired button.

↳ The user interface for setting the desired parameter is displayed.

For some parameters the setting is more than just a numerical value. These more complex parameters are described in detail below.

Mode AUTO Selecting the sewing program



Fig. 29: Selecting the sewing program

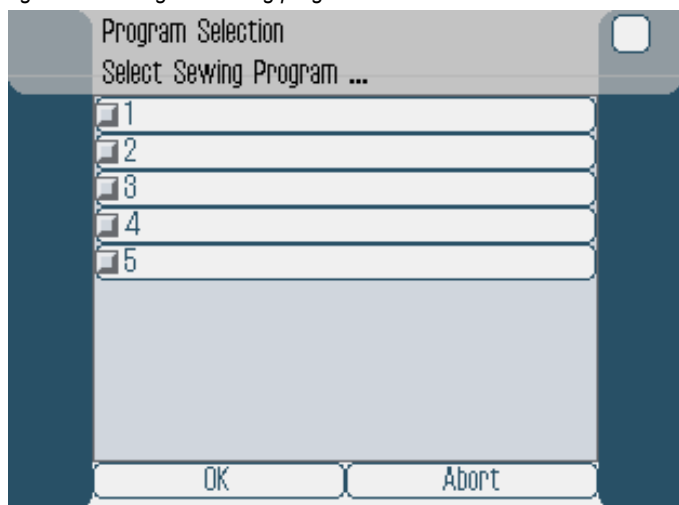

To select a sewing program:



1. Tap the desired sewing program.

↳ The selected sewing program is displayed in an activated control field within the line.

2. Tap the **OK** button.

↳ The selected sewing program is loaded in **AUTO** operating mode.

You can tap the **Abort** button to cancel the selection of the program.

↳ The user interface for **AUTO** operating mode is displayed.

Mode AUTO Setting the sewing material size



Abb. 30: Setting the sewing material size

Size Group		GB, USA Men			
34	36	38	35	37	39
40	42	44	41	43	45
46	48	>> 50	47	49	51
52	54	56	53	55	57
58	60	62	59	61	63

The following information is displayed:

- Divided into up to 4 segments, each size table illustrates the corresponding size groups. The currently selected size is indicated by a double arrow (>>).
- The sizes marked in red indicate the sizes in which the sewing program was created or modified.

To set the sewing material size:



1. Select the size table.

2. Tap the desired sewing material size.

↳ The user interface for **AUTO** operating mode is displayed.

Mode AUTO Temporarily setting the fullness value until the next sewing step



Fig. 31: Temporarily setting the fullness value

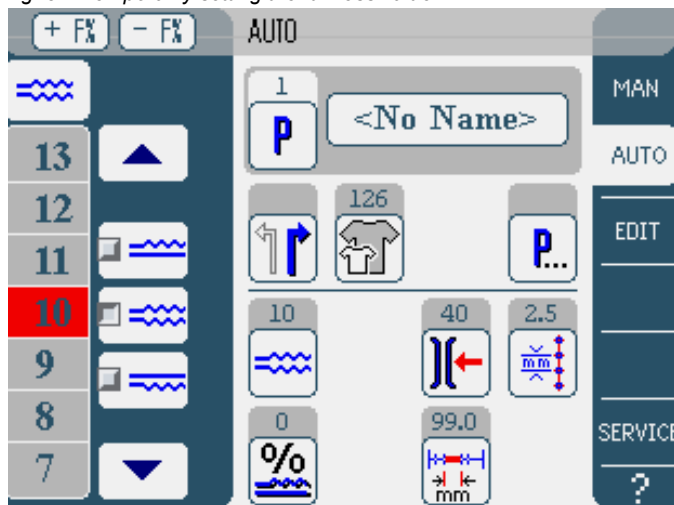

Buttons for manually inputting the fullness are displayed in the left pane.

Symbols/buttons	Meaning
	Input the fullness. The fullness setting is displayed by a button highlighted in red.
	Select the type of fullness: <ul style="list-style-type: none"> • Top (top feed) • Lower (lower transport) • Top and bottom (differential top and bottom feed) The fullness selected is displayed in an activated control field.
	Display of further buttons for inputting the fullness. The buttons 0 to 16 are available for input.

To set the fullness:



1. Select the type of fullness.
↳ The type of fullness selected is displayed in an activated control field within the symbol.
2. If a higher or lower degree of fullness is required, use the arrows to display more buttons.
3. Input the fullness using the buttons **0** to **16**.



Information

The fullness value remains active until the next sewing step.

Mode AUTO Correcting the fullness value

You can adapt the entire fullness of a sewing program quickly to the sewing material to be processed. You can correct the fullness value using either the buttons **+ F%** and **- F%** or the fullness correction parameter.



Fig. 32: Correcting the fullness value

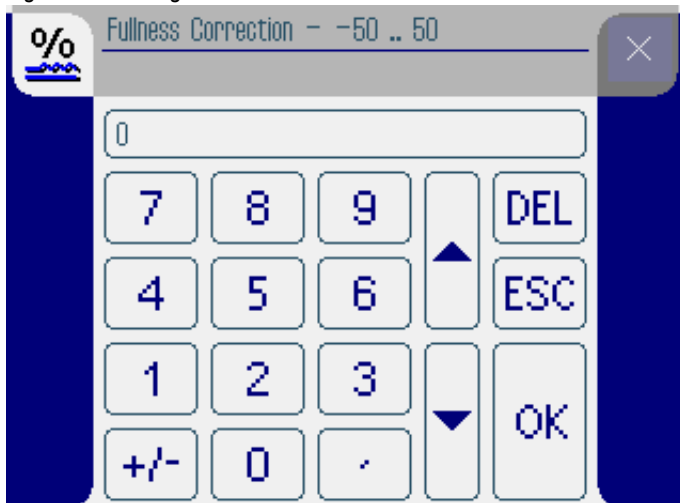

To correct the fullness value:



1. Input the correction value for the fullness in %.
Information for inputting numeric values:  p. 49.

2. Tap the **OK** button.
 - ↳ The correction value is saved, and the previous user interface is displayed again.



Information

If changed in **AUTO** operating mode, the new correction value remains active until the controller changes to the next program.

Mode AUTO Other program parameters



A tap on the **Other program parameters** button will bring up an overview of all available parameters.

Fig. 33: Other program parameters in operating mode AUTO

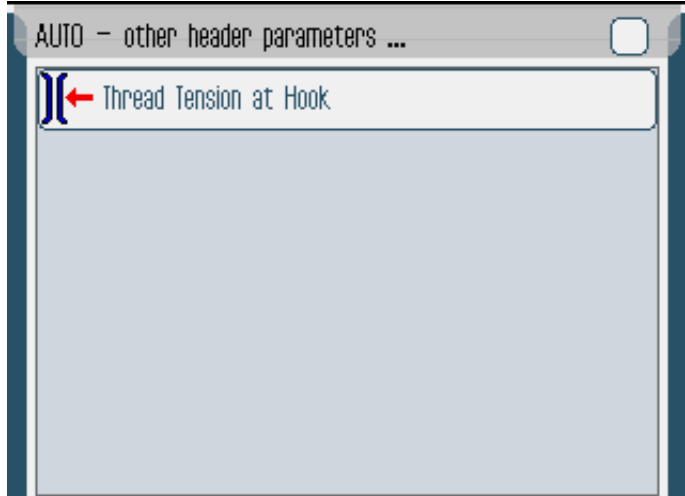

Parameter	Meaning	Value range
Thread Tension at Hook	Looper thread tension	1 – 99

5.4.2 Sewing process

1. Select a sewing program (📖 p. 56).
 - ↳ The program number and name of the sewing program are displayed on the user interface. If no name has been saved for the selected sewing program, <No Name> is displayed.



2. Select the right or left piece to be sewn by tapping
3. Set the sewing material size (📖 p. 57).
4. Press the pedal forward and sew the seam.
 - ↳ The sewing progress is displayed graphically in the left pane as a red bar.

Fig. 34: Sewing process

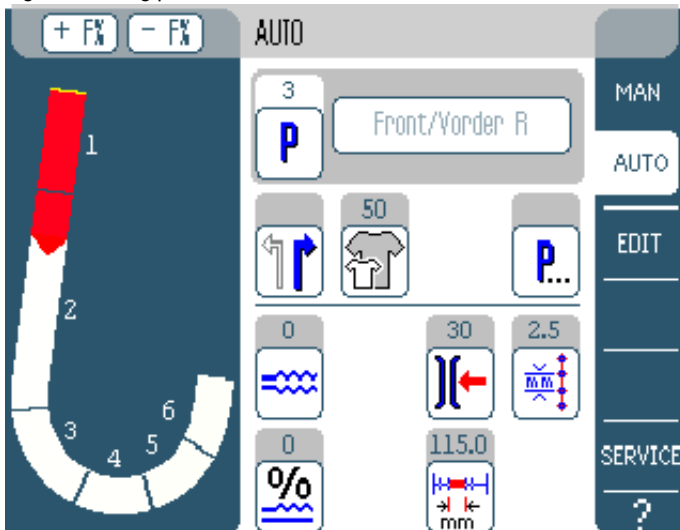

- ↳ The remaining sewing length per sewing step is displayed:



Correcting the fullness before the seam



1. Press the pedal to position 0.
 2. Change the fullness correction using the buttons **+ F%** or **- F%**.
 3. Press the pedal forward and sew.
- ↳ The changed fullness value is applied and displayed.

Correcting the fullness during the seam



1. Press the pedal to position 0.
 2. Use the button  to adjust the fullness.
 3. Press the pedal forward and sew.
- ↳ The changed fullness value is applied and displayed.

Changing parameters during the seam



1. Press the pedal to position 0.
 2. Change the desired parameter on the control panel.
 3. Press the pedal forward and sew.
- ↳ The seam will be sewn using the altered parameter value.

Canceling sewing program



1. Press the pedal to position -2.
- ↳ The sewing program is canceled.

5.5 Operating mode EDIT

Fig. 35: Operating mode EDIT

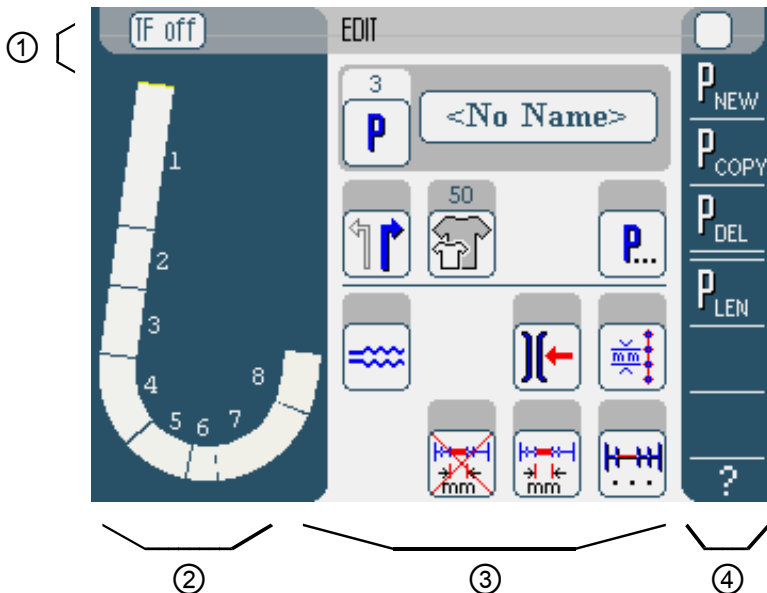

Header (1)

Operating mode **EDIT** is displayed. The buttons **TF on** / **TF off** are used to switch the tape feed on / off (610-10 only) or to display if sewing takes place with or without tape.

Left pane (2)

The graphical representation of the entire seam, divided into the number of programmed sewing steps, is displayed here.

Middle pane (3)

Existing sewing programs can be edited here ( p. 64).







The number and the name of the selected sewing program are displayed, together with the symbols for all the parameters that can be set. The gray fields above the parameter symbols show the respective current values.



Right pane (4)

Here, sewing programs can be created (📖 p. 69), deleted (📖 p. 79), copied (📖 p. 79) and optimized (📖 p. 79).

5.5.1 Parameters that can be set

The following table lists the parameters that can be set in **EDIT** operating mode.

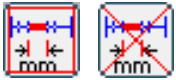
Symbols/buttons	Meaning
	Changing the program name
	There is only one display in EDIT operating mode. A new sewing program is automatically assigned the next free program slot.
	Select the right or left piece to be sewn
	Set the sewing material size, 📖 p. 65
	Other program parameters in operating mode EDIT , 📖 p. 60
	Temporarily setting the fullness value until the next sewing step, 📖 p. 58
	Setting the needle thread tension

Symbols/buttons	Meaning
	Setting the stitch length in mm
	Switch the seam length measurement in the current sewing step on or off
	Other sewing step parameters in EDIT operating mode,  p. 69

To set a parameter:



1. Tap the desired button.

 The user interface for setting the desired parameter is displayed.

For some parameters the setting is more than just a numerical value. These more complex parameters are described in detail below.

Mode EDIT Setting the sewing material size



Abb. 36: Setting the sewing material size

Size Group		GB, USA Men			
34	36	38	35	37	39
40	42	44	41	43	45
46	48	>> 50	47	49	51
52	54	56	53	55	57
58	60	62	59	61	63

The following information is displayed:

- Divided into up to 4 segments, each size table illustrates the corresponding size groups. The currently selected size is indicated by a double arrow (>>).
- The sizes marked in red indicate the sizes in which the sewing program was created or modified.

To set the sewing material size:



1. Select the size table.
 2. Tap the desired sewing material size.
- ↳ User interface **EDIT** is displayed.



Mode EDIT Setting the fullness in the current sewing step

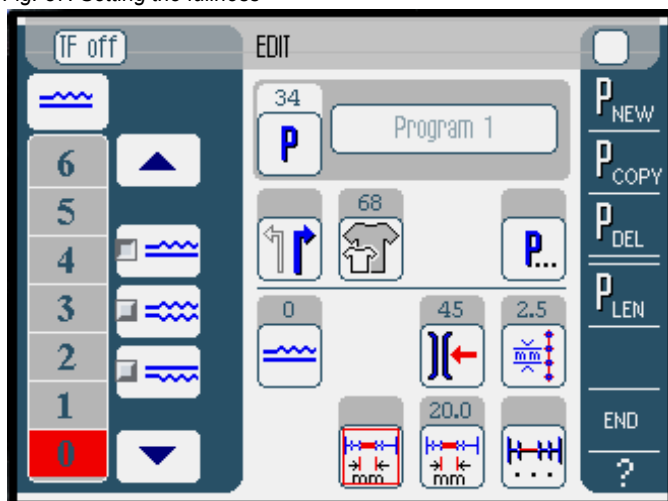

Fig. 37: Setting the fullness



Buttons for manually inputting the fullness are displayed in the left pane.

Symbols/buttons	Meaning
	Input the fullness. The fullness setting is displayed by a button highlighted in red.
	Select the type of fullness: <ul style="list-style-type: none"> • Top (top feed) • Lower (lower transport) • Top and bottom (differential top and bottom feed) The fullness selected is displayed in an activated control field.
	Display of further buttons for inputting the fullness. The buttons 0 to 16 are available for input.

To set the fullness:



1. Select the type of fullness.
 - ↳ The type of fullness selected is displayed in an activated control field within the symbol.
2. If a higher or lower degree of fullness is required, use the arrows to display more buttons.
3. Input the fullness using the buttons **0** to **16**.

Mode EDIT Other program parameters



A tap on the **Other program parameters** button will bring up an overview of all available parameters.

Fig. 38: Other program parameters in operating mode EDIT

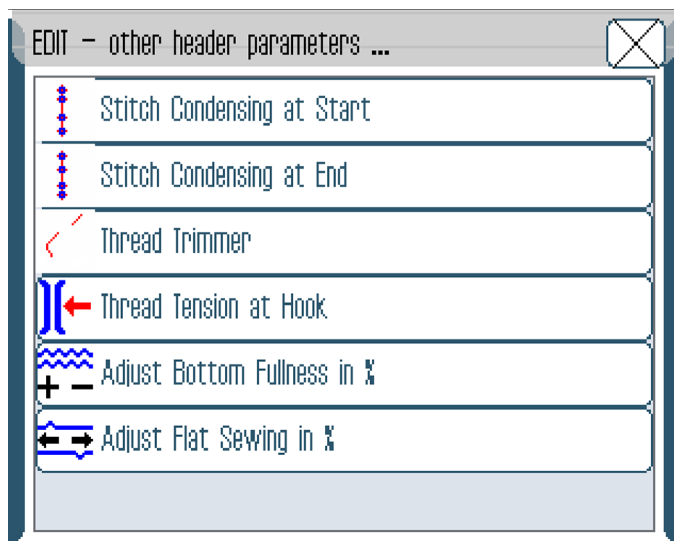

Parameter	Meaning	Value range
Stitch Condensing at Start	Stitch condensing at seam beginning on (= 1) or off (= 0)	0 – 1
Stitch Condensing at End	Stitch condensing at seam end on (= 1) or off (= 0)	0 – 1
Thread Trimmer	Thread trimmer on (= 1) or off (= 0)	0 – 1
Thread Tension at Hook	Looper thread tension	1 – 99
Adjust Bottom Fullness in %	Fullness correction parameter bottom (%)	-50 – 50
Adjust Flat Sewing in %	Flat sewing correction, only when sewing without fullness (%)	0 – 50

Mode EDIT Other sewing step parameters



A tap on the **Other sewing step parameters** button will bring up an overview of all available parameters. Before you can make changes, you need to select the corresponding step in the program.

Abb. 39: Other sewing step parameters in operating mode EDIT

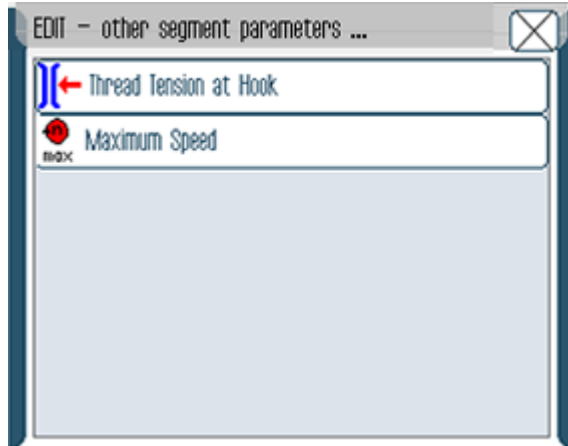

Parameter	Meaning	Value range
Thread Tension at Hook	Looper thread tension	1 – 99
Maximum Speed	Maximum speed	100 – 4000

5.5.2 Creating a new sewing program (PROGRAMMING)

Prerequisite:

- Operating mode **EDIT** is displayed.

Proceed as follows to create a new sewing program:



1. Tap the **P_{NEW}** button.
- ↳ The **PROGRAMMING** user interface is displayed. Pressing the **P** button displays the number of the next free program slot.

Fig. 40: Creating a new sewing program (1)

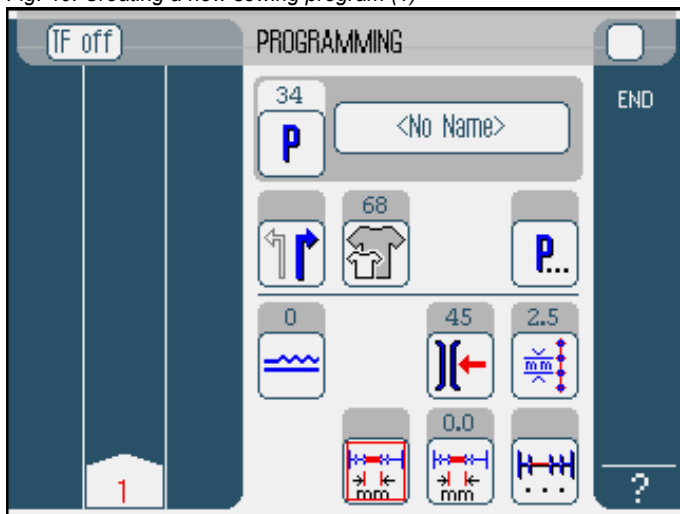

2. Tap **<No Name>** and input a name.

Information for inputting text: p. 46.



Information

If no name is input for the sewing program, **<No Name>** continues to be displayed.

- ↳ The left pane displays the 1st sewing step with its number.
3. Set the sewing material size (p. 65).
4. Set all parameters for the 1st sewing step.
5. Use the buttons **TF on** and **TF off** to specify if the tape feed is turned on or off during this sewing step (610-10 only).



Important

In the 1st sewing step, it is not possible to feed any tape. This is why the buttons will not be displayed until the 2nd sewing step.



Information

All entries only refer to the corresponding sewing step.

6. Sew the 1st sewing step, or manually input the length of the sewing step using the seam length measurement parameter.
 7. Select the next sewing step by tapping the number of the 1st sewing step or by pressing the Knee button.
- ↳ The left pane displays the 2nd sewing step with its number.

Fig. 41: Creating a new sewing program (2)

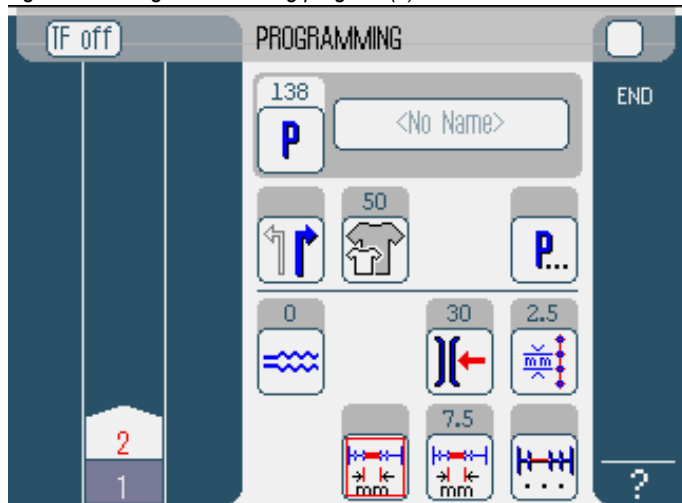

8. Repeat sewing step 2 until all the sewing steps have been programmed.

9. When all sewing steps have been programmed, tap the **END** button or cut off the thread.

↳ There are 3 variants for the sewing program response - depending on the user's input method:

Variant	Program display
The last programmed sewing step was sewn, but thread was not cut off, and program was ended with END .	Continue with 10.
The last programmed sewing step was sewn, and thread was cut off.	Continue with 11.
All sewing steps were input manually and ended with END .	Continue with 11.

10. If the thread was not cut after sewing, the message *Cut off thread* appears.

↳ The message is cleared, and the following selection window appears:

Fig. 42: Creating a new sewing program, selection window

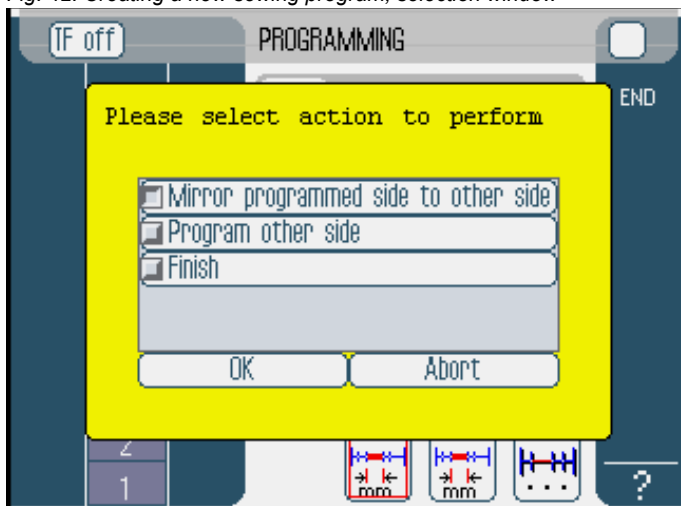

11. Select whether the new sewing program should be mirrored for the other side of the sewing material (*Mirror programmed side to other side*), the other side of the sewing material should be programmed (*Program other side*) or the programming should be ended (*Finish*).
 - ↪ The selected function is indicated by an activated control field.
12. Tap the **OK** button.
 - ↪ The sewing program is saved. Depending on which function is selected, different buttons are displayed:

Function	Button
Mirror programmed side to other side	AUTO
Program other side	PROGRAMMING
Finish	AUTO

Tapping the **Abort** button closes the selection window and brings up the **AUTO** user interface.

















Important

All previously entered data is deleted!

Parameters that can be set

The following table describes the parameters that can be set on the **PROGRAMMING** user interface.

Symbols/buttons	Meaning
	Input the program name
	There is only one display under PROGRAMMING . A new sewing program is automatically assigned the next free program slot.
	Select the right or left piece to be sewn

Symbols/buttons	Meaning
	Set the sewing material size,  p. 75
	Other program parameters under PROGRAMMING ,  p. 77
	Set the fullness in the current sewing step,  p. 76
	Set the needle thread tension in the current sewing step
	Set the stitch length in mm in the current sewing step
	Switch the seam length measurement in the current sewing step on or off
	Other sewing step parameters under PROGRAMMING ,  p. 78

To set a parameter:



1. Tap the desired button.

 The user interface for setting the desired parameter is displayed.

For some parameters the setting is more than just a numerical value. These more complex parameters are described in detail below.

Mode **PROGRAMMING** Setting the sewing material size



Abb. 43: Setting the sewing material size

Size Group		GB, USA Men			
34	36	38	35	37	39
40	42	44	41	43	45
46	48	>> 50	47	49	51
52	54	56	53	55	57
58	60	62	59	61	63

The following information is displayed:

- Divided into up to 4 segments, each size table illustrates the corresponding size groups. The currently selected size is indicated by a double arrow (>>).
- The sizes marked in red indicate the sizes in which the sewing program was created or modified.

To set the sewing material size:



1. Select the size table.
 2. Tap the desired sewing material size.
- ↳ The **PROGRAMMING** user interface is displayed.





Mode **Setting the fullness**
PROGRAMMING

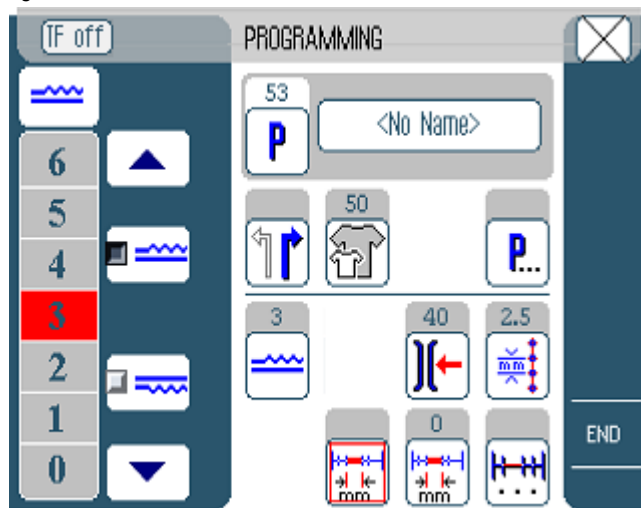

Fig. 44: Set the fullness



Buttons for manually inputting the fullness are displayed in the left pane.

Symbols/buttons	Meaning
 	Input the fullness. The fullness setting is displayed by a button highlighted in red.
	Select the type of fullness: <ul style="list-style-type: none"> • Top (top feed) • Lower (lower transport) • Top and bottom (differential top and bottom feed) The fullness selected is displayed in an activated control field.
 	Display of further buttons for inputting the fullness. The buttons 0 to 16 are available for input.

To set the fullness:



1. Select the type of fullness.
 - ↳ The type of fullness selected is displayed in an activated control field within the symbol.
2. If a higher or lower degree of fullness is required, use the arrows to display more buttons.
3. Input the fullness using the buttons **0** to **16**.

Mode PROGRAMMING

Other program parameters



A tap on the **Other program parameters** button will bring up an overview of all available parameters.

Fig. 45: Other program parameters

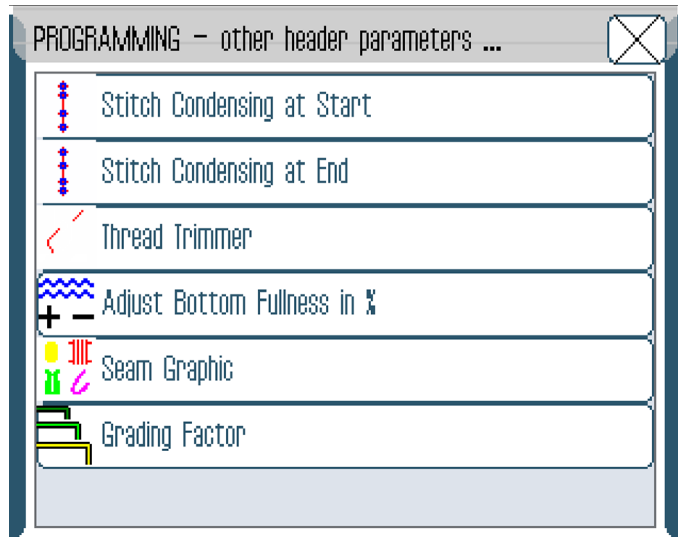

Parameter	Meaning	Value range
Stitch Condensing at Start	Stitch condensing at seam beginning on (= 1) or off (= 0)	0 – 1
Stitch Condensing at End	Stitch condensing at seam end on (= 1) or off (= 0)	0 – 1
Thread Trimmer	Thread trimmer on (= 1) or off (= 0)	0 – 1
Adjust Bottom Fullness in %	Fullness correction parameter bottom (%)	-50 – 50
Seam Graphic	Seam pattern: 1 = Pre-ruffle sleeve 2 = Tape front 3 = Tape back	1 – 3
Grading Factor	Grading factor (% per size)	0.0 – 6.0

Mode PROGRAMMING

Other sewing step parameters



A tap on the **Other sewing step parameters** button will bring up an overview of all available parameters.

Abb. 46: Other sewing step parameters

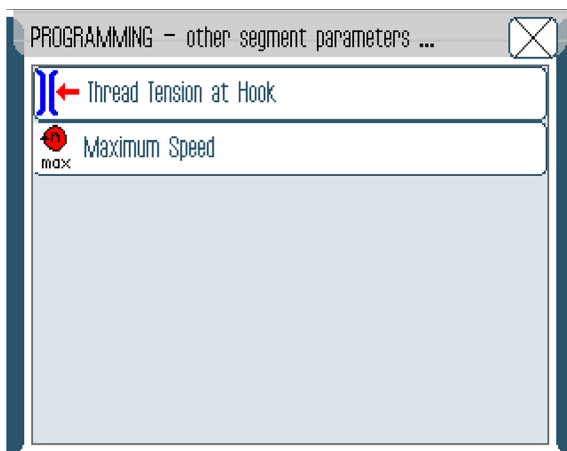

Parameter	Meaning	Value range
Thread Tension at Hook	Looper thread tension	1 – 99
Maximum Speed	Maximum speed	100 – 4000

5.5.3 Copying the sewing program

Prerequisite:

- Operating mode **EDIT** is displayed.

Proceed as follows to copy an existing sewing program:



1. Select a sewing program ( p. 56).



2. Tap the **P_{COPY}** button.

↳ The sewing program is copied and saved in the next free program slot. An appropriate message is displayed.

5.5.4 Deleting the sewing program

Prerequisite:

- Operating mode **EDIT** is displayed.

Proceed as follows to delete an existing sewing program:



1. Select a sewing program ( p. 56).



2. Tap the **P_{DEL}** button.

↳ A message is displayed asking whether you really wish to delete the active sewing program.

3. Confirm deletion with a tap on the **Yes** button.

↳ The sewing program is deleted. An appropriate message is displayed.

5.5.5 Length correction (LENGTH CORRECTION)

All the sewing steps are graded with the same factor.

In some cases, the preset gradation is not suitable.

You can use the length correction to achieve these local adjustments.

Prerequisite:

- Operating mode **EDIT** is displayed.

Use the length correction as follows:



1. Tap the **P_{LEN}** button.
 - ↳ The **LENGTH CORRECTION** user interface is displayed.

Fig. 47: Length correction (1)

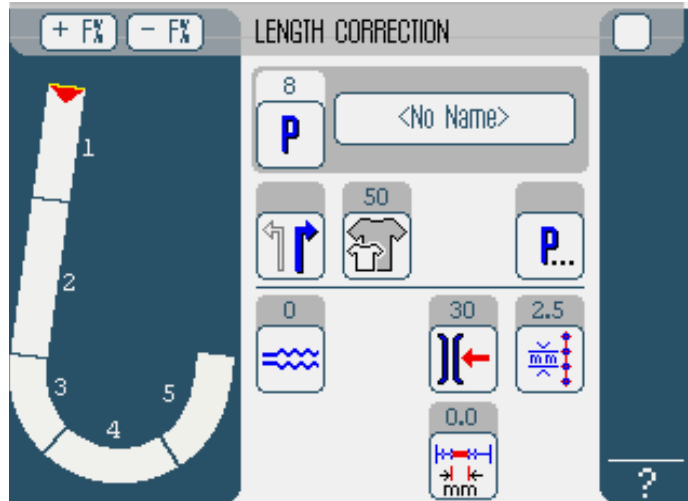

2. Complete the sewing step in the appropriate size.
 - ↳ The sewn seam segments are measured automatically, and the sewing steps are adjusted in the sewing program.
3. Select the next sewing step by tapping the number of the 1st sewing step or by pressing the Knee button.
 - ↳ The sewing progress is displayed graphically.

Fig. 48: Length correction (2)

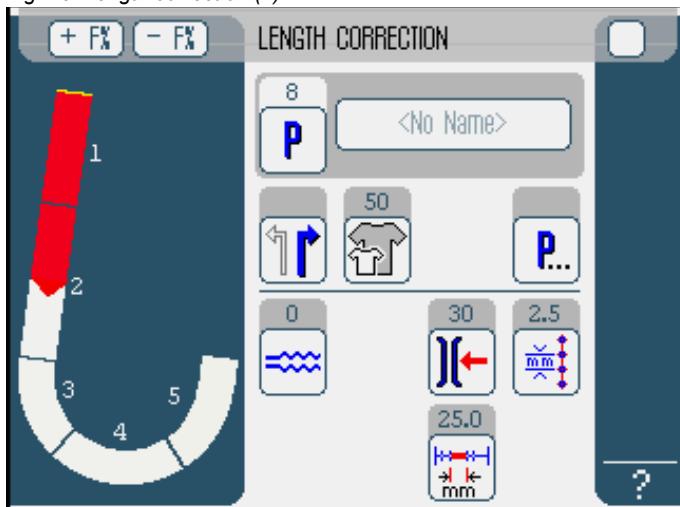

4. Do the same with all further sewing steps.
 5. After the last sewing step tap the **END** button.
- ↳ This closes the length correction, and the operating mode **EDIT** (📖 p. 63) opens.

5.6 Displaying software version

To display the software version:



1. Switch the machine off and on (📖 p. 20).
- ↳ The following appears on the display:
- On the left, the class
 - On the right, the firmware
- ↳ The machine performs a reference run.
- ↳ The controller starts in the operating mode that was active when it was switched off - **MAN** or **AUTO**.

5.7 Operating mode SERVICE

More information on the contents of Service mode can be found in the 📖 *Service Instructions*.

6 Maintenance

This chapter describes maintenance work that needs to be carried out on a regular basis to extend the service life of the machine and achieve the desired seam quality.

Advanced maintenance work may only be carried out by qualified specialists ( *Service Instructions*).

WARNING



Risk of injury from sharp parts!

During maintenance work, the machine may start up unintentionally. Punctures and cutting possible.

Switch the machine off prior to any maintenance work.

WARNING



Risk of injury from moving parts!

During maintenance work, the machine may start up unintentionally. Crushing is possible.

Switch the machine off prior to any maintenance work.

Maintenance interval

Work to be carried out	Operating hours			
	8	40	160	500
Machine head				
Removing lint and thread remnants	●			
Remove any lint in the area below the throat plate	●			
Check oil level at machine head	●			
Check oil level at looper drive housing		●		
Pneumatic system				
Checking the operating pressure	●			
Check the water level in the pressure controller	●			
Clean the filter element in the maintenance unit				●
Check the tightness of the system				●

6.1 Cleaning

WARNING



Risk of injury from flying particles!

Flying particles can enter the eyes, causing injury.

Wear safety goggles.

Hold the compressed air gun so that the particles do not fly close to people.

Make sure no particles fly into the oil sump.

NOTICE

Property damage from soiling!

Lint and thread remnants can impair the operation of the machine.

Clean the machine as described.

NOTICE

Property damage from solvent-based cleaners!

Solvent-based cleaners may damage paintwork on the machine.

Use only solvent-free substances for cleaning.

You must clean the following areas that are prone to soiling:

- Throat plate
- Hook
- Bobbin case and inner area
- Thread trimmer
- Needle
- Motor fan sieve
- Transport belts
- Foot area
- Belt tensioner

Clean the machine as follows:



1. Remove any lint and thread remnants using a compressed air pistol or a brush.
2. Remove sewing dust and cutting waste from the oil pan.

6.2 Lubricating

CAUTION



Risk of injuries from contact with oil!

Oil can cause a rash if it comes into contact with skin.

Avoid skin contact with oil.

If oil has come into contact with your skin, wash the affected areas thoroughly.

CAUTION



Risk of environmental damage from oil!

Oil is a pollutant and must not enter the sewage system or the soil.

Carefully collect up used oil.

Dispose of used oil and oily machine parts in accordance with national regulations.

The machine must be lubricated at regular intervals ( p. 83). Complete the following steps when lubricating the machine:

- Checking the oil level
- Lubricating the machine head
- Lubricating the looper

Lubrication of the machine head

Fig. 49: Lubrication of the machine head

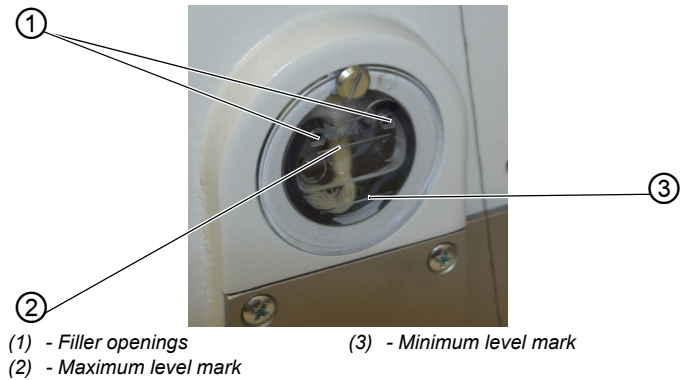

Checking the oil level

NOTICE

Property damage from incorrect oil level!

Too little or too much oil can damage the machine.

Top off oil as described.



Proper setting

The oil level must always be between the minimum level mark (3) and the maximum level mark (2).

Refilling oil

NOTICE

Property damage from incorrect oil!

Incorrect oil types can result in damage to the machine.

Use only oil that corresponds to the following specifications.

For topping off the oil reservoir, use only lubricating oil **DA 10** or oil of equivalent quality with the following specifications:

- Viscosity at 40 °C: 10 mm²/s
- Flash point: 150 °C

You can order the lubricating oil from our sales offices using the following part numbers:

Container	Part no.
250 ml	9047 000011
1 l	9047 000012
2 l	9047 000013
5 l	9047 000014

If necessary, fill oil through the filler openings (1) as follows:



1. Add oil up to but not past the maximum level mark (2).

Looper lubrication

Fig. 50: Looper lubrication

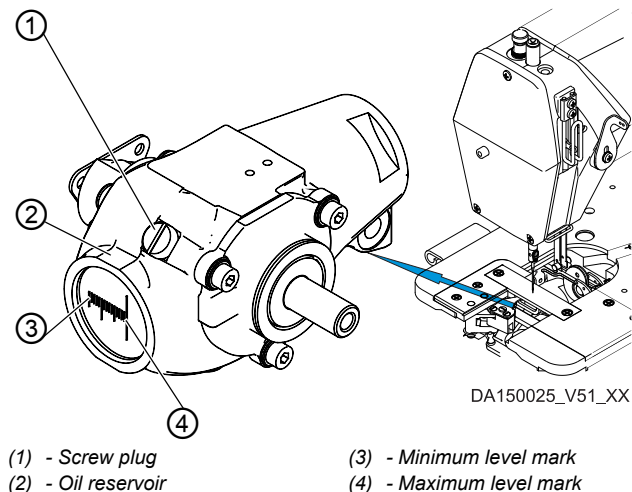

Checking the oil level

NOTICE

Property damage from incorrect oil level!

Too little or too much oil can damage the machine.

Top off oil as described.



1. Tilt the machine head ( p. 38).
2. Check the fill level in the oil reservoir (2) of the looper drive housing.
3. Erect the machine head again.



Proper setting

The oil level must always be between the minimum level mark (3) and the maximum level mark (4) with the machine head tilted back halfway.

Refilling oil

If necessary, fill oil through the filler opening as follows:



1. Tilt the machine head ( p. 38).
2. Loosen the screw plug (1) on the filler opening.
3. Add oil up to but not past the maximum level marking (4).
4. Tighten the screw plug (1).
5. Erect the machine head again.

6.3 Servicing the pneumatic system

6.3.1 Setting operating pressure

NOTICE

Property damage from incorrect setting!

Incorrect operating pressure can result in damage to the machine.

Ensure that the machine is only used when the operating pressure is set correctly.



Proper setting

Refer to the **Technical data** (📖 p. 109) chapter for the permissible operating pressure. The operating pressure cannot deviate by more than ± 0.5 bar.

Check the operating pressure on a daily basis: You can read the operating pressure on the pressure gage (2).

Fig. 51: Checking the operating pressure

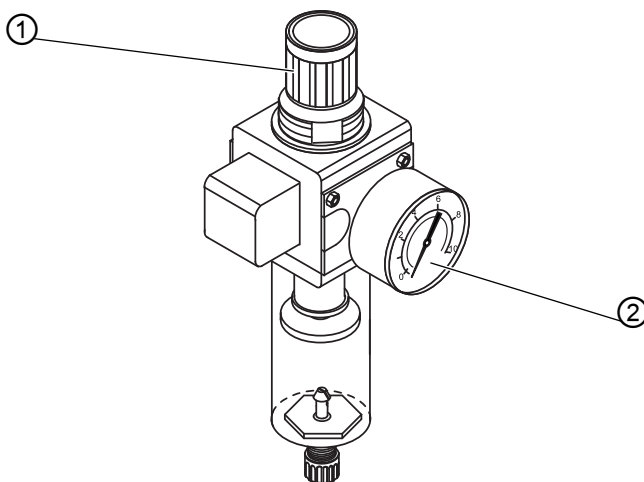

(1) - Pressure controller

(2) - Pressure gage

DA150011_V52_XX

To set the operating pressure:



1. Pull the pressure controller (1) up.
2. Turn the pressure controller (1) until the pressure gage (2) indicates the desired operating pressure.
 - Increase pressure = turn clockwise
 - Reduce pressure = turn counterclockwise
3. Push the pressure controller (1) down.

6.3.2 Draining the water condensation

NOTICE

Property damage from excess water condensation!

Too much water condensation can result in damage to the machine.

If necessary, drain the condensation water as described.

Water condensation will accumulate in the water separator (2) of the compressed air maintenance unit.



Proper setting

Water condensation must not rise up to the level of the filter element (1).

Check the water level in the water separator (2) on a daily basis.

Fig. 52: Draining the water condensation

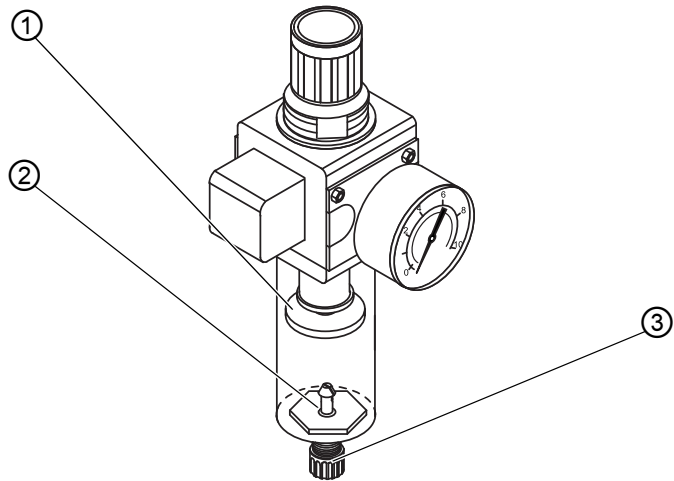

(1) - Filter element
(2) - Water separator

(3) - Drain screw

Drain water condensation as follows:



1. Disconnect the machine from the compressed air supply.
2. Place the collection tray under the drain screw (3).
3. Disconnect the connection hose from the compressed air supply.
4. Unscrew the drain screw (3) completely.
5. Allow water to drain into the collection tray.
6. Re-tighten the drain screw (3).
7. Connect the machine to the compressed air supply.

6.3.3 Cleaning the filter element

NOTICE

Damage to the paintwork from solvent-based cleaners!

Solvent-based cleaners damage the filter.

Use only solvent-free substances for washing out the filter tray.

Fig. 53: Cleaning the filter element

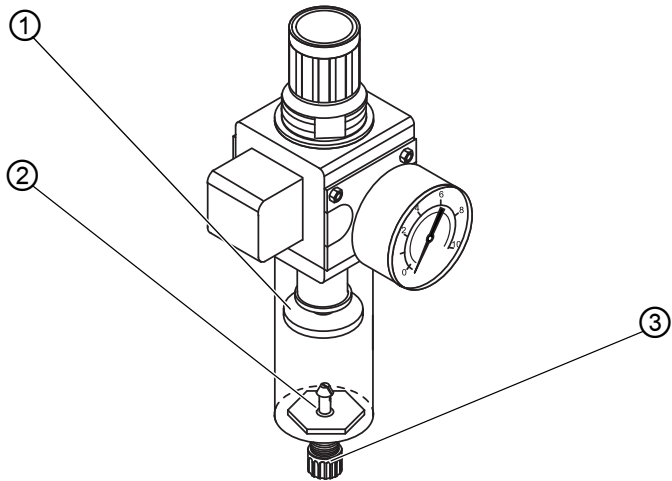

(1) - Filter element
(2) - Water separator

(3) - Drain screw

DA15001LV52_XX

Clean the filter element as follows:



1. Disconnect the machine from the compressed air supply.
2. Drain the water condensation ( p. 93).
3. Unscrew the water separator (2).
4. Unscrew the filter element (1).
5. Blow out the filter element (1) using a compressed air gun.
6. Wash out the filter tray using benzine.

7. Tighten the filter element (1).
8. Tighten the water separator (2).
9. Tighten the drain screw (3).
10. Connect the machine to the compressed air supply.

7 Setup

WARNING



Risk of injury from cutting parts!

Cutting injuries may be sustained while unpacking and setting up the machine.

Only qualified specialists may set up the machine.

Wear safety gloves.

WARNING



Risk of injury from moving parts!

Crushing injuries may be sustained while unpacking and setting up the machine.

Only qualified specialists may set up the machine.

Wear safety shoes.

7.1 Checking the scope of delivery

The scope of delivery depends on your specific order.
Check that the scope of delivery is correct after taking delivery.

7.2 Removing the transport locks

Remove all transport locks before setting up the machine.

- Wooden blocks on the machine head
- Safety clips on the stand feet

7.3 Assembling the stand

Fig. 54: Assembling the stand

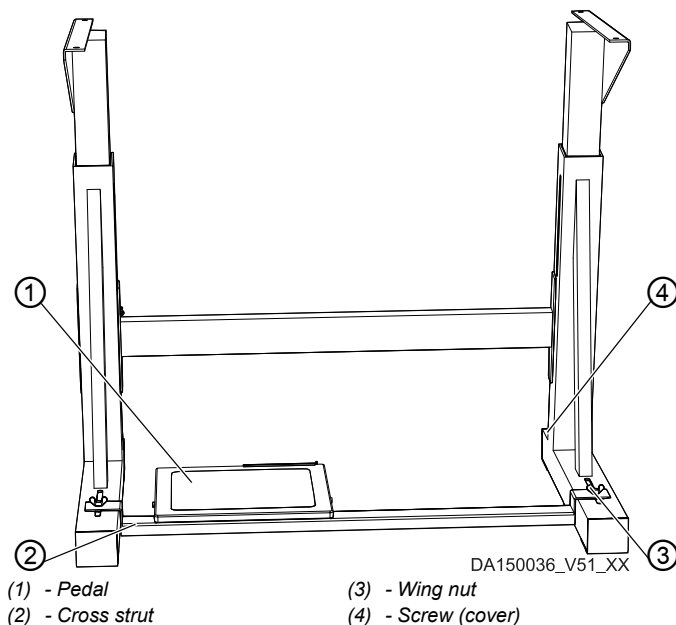

Fit the stand as follows:



1. Tighten the pedal (1) on the cross strut (2).
2. Tighten the cross strut (2) to the stand using the screw and the wing nut (3).
3. After the machine has been fully assembled, adjust the pedal ( p. 101).
4. Turn the screw (4) to ensure that the stand is positioned securely. All 4 feet of the stand must be in contact with the floor.

7.4 Tabletop

Ensure that the tabletop has sufficient load-bearing capacity and strength. If you want to make your own tabletop, use the dimensions given in the diagram (*Appendix*,  p. 137) as an example.

7.4.1 Assembling the controller

To fit the controller:



1. Use screws to mount the controller to the underside of the tabletop at positions (1) and (2). The side housing the type plate will be pointing to the left.

Fig. 55: Assembling the controller

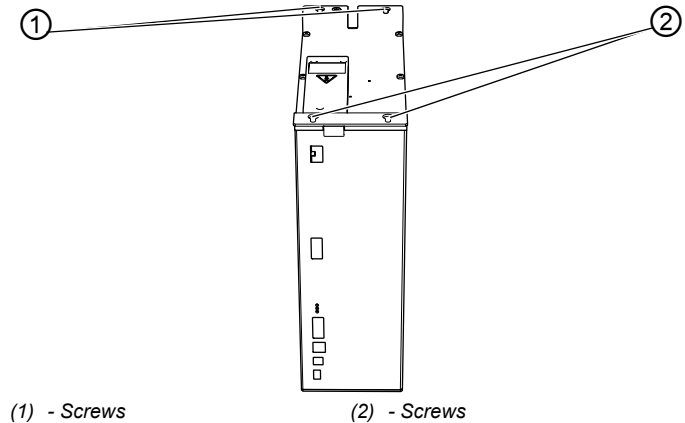

7.4.2 Assembling thread reel holder

Fig. 56: Assembling the thread reel holder (final state)



To assemble the thread reel holder:



1. Insert the thread reel holder tube (1) into the hole of the tabletop.
2. Assemble the thread reel holder tube (1) using the included nuts (2) and washers (3).
3. Align thread reel holder and thread guide.



Important

The thread guide must be positioned vertically above the thread reel holder.

Fig. 57: Assembling the thread reel holder (tabletop upper side)

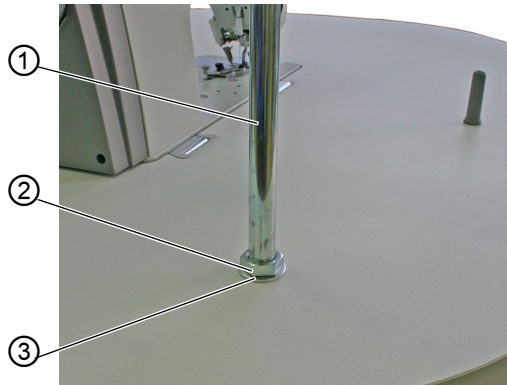

- (1) - Thread reel holder tube
- (2) - Nut
- (3) - Washer

Fig. 58: Assembling the thread reel holder (tabletop underside)

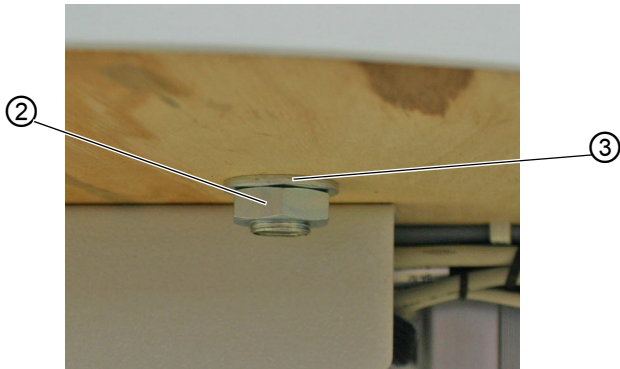

- (2) - Nut
- (3) - Washer

7.5 Setting the working height

WARNING



Risk of injury from moving parts!

The tabletop can sink under its own weight when the screws on the stand bars are loosened. Crushing is possible.

When loosening the screws, ensure that your hands are not jammed.

CAUTION



Risk of musculoskeletal damage from incorrect setting!

The operator can sustain musculoskeletal damage if failing to comply with the ergonomic requirements.

Adjust the working height to the body height of the person who will operate the machine.

The working height can be adjusted between 750 mm and 950 mm (measured to the upper edge of the tabletop).

Fig. 59: Setting the working height

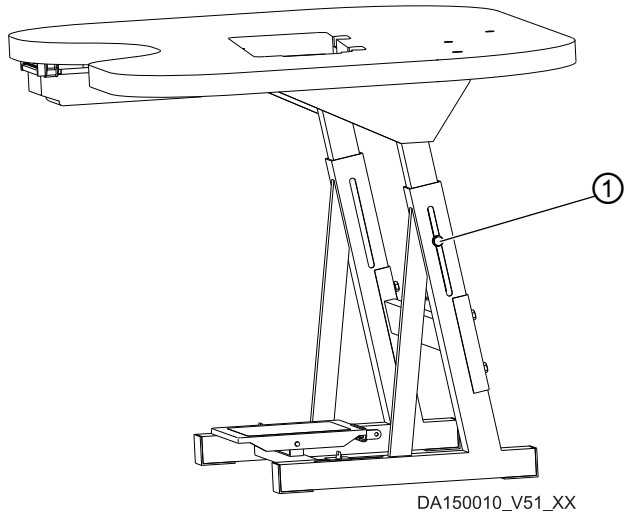

(1) - Screw

To set the working height:



1. Loosen the screws (1) on both stand bars.
2. To avoid jamming, slide the tabletop in or out evenly at both sides.

The scales on the outer sides of the stand bars serve as an adjustment aid.

3. Tighten the screw (1) on both bars of the stand.

7.6 Adjusting the pedal

NOTICE

Property damage from incorrect setting!

If done carelessly, adjusting the settings separately can cause damage to the machine.

Always adjust the inclination and position of the pedal as a function of one another.

Fig. 60: Adjusting the pedal

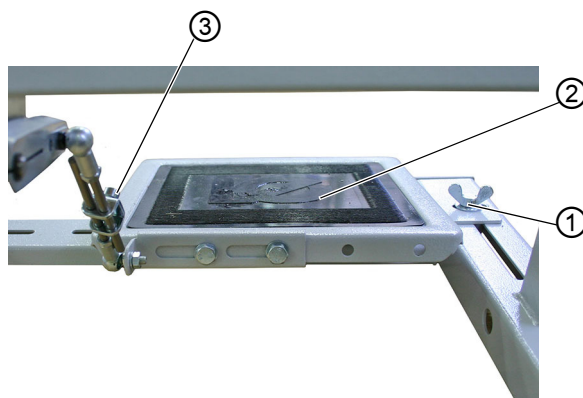

(1) - Wing nut
(2) - Pedal

(3) - Screw

Inclination of the pedal

The pedal (2) should be tilted to a degree that allows the operator to move the pedal forward and backward without a problem.

You set the inclination of the pedal as follows:



1. Loosen the screw (3).
2. Adjust pedal (2) accordingly.
3. Re-tighten the screw (3).

Position of the pedal

The pedal (2) is attached to the cross strut of the stand. You can adjust the position of the pedal individually by shifting the position of the cross strut.

You set the position of the pedal as follows:



1. Loosen the screw with wing nut (1) on both sides of the stand.
2. Slide the cross strut that holds the pedal (2) forward or backward.
3. Tighten the screw with wing nut (1) on both sides of the stand.

7.7 Electrical connection

DANGER



Risk of death from live components!

Unprotected contact with electricity can result in serious injuries or death.

Only qualified specialists may perform work on electrical equipment.



Important

The voltage on the type plate of the sewing motor must correspond to the mains voltage.

You establish the electrical connection as follows:



1. Connect the machine as specified in the wiring diagram (*Appendix*,  *p. 137*).

7.7.1 Connecting the controller

Fig. 61: Connecting the controller

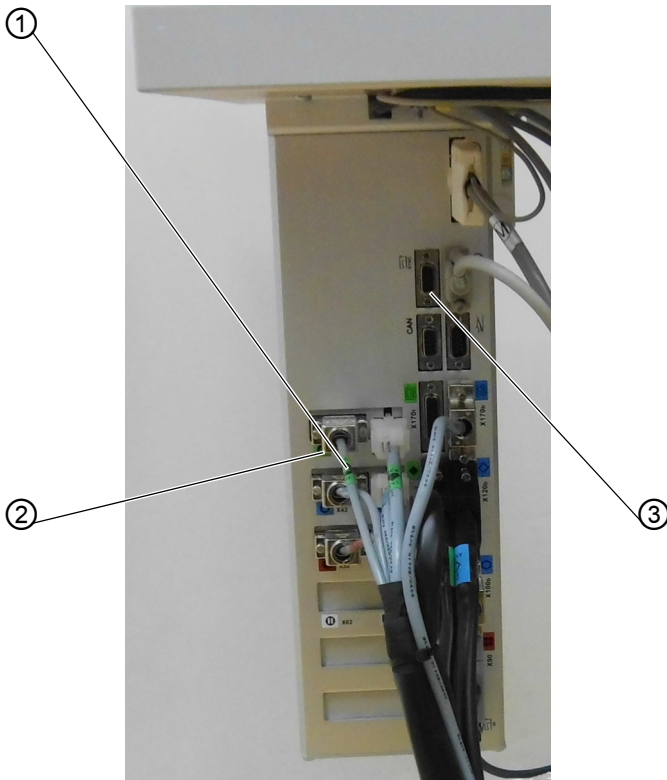

(1) - Cable
(2) - Plugs

(3) - Connection

To connect the controller:



1. Lay all cables (1) to the controller and fix them in place with cable ties.
2. Insert all plugs (2) following the marking on the rear of the controller.



Important

Cable (1) and connection (3) have the same designation / symbol!

3. Screw all plugs to the connections.

7.7.2 Establishing equipotential bonding



Important

Before putting the machine into operation, you must establish equipotential bonding in all necessary places.

To establish equipotential bonding:



1. Establish equipotential bonding as specified in the wiring diagram (*Appendix*,  p. 137).

7.8 Pneumatic connection

NOTICE

Property damage from oily compressed air!

Oil particles in the compressed air can cause malfunctions of the machine and soil the sewing material.

Ensure that no oil particles enter the compressed air supply.

NOTICE

Property damage from incorrect system pressure!

Incorrect system pressure can result in damage to the machine.

Ensure that the machine is only used when the system pressure is set correctly.

The pneumatic system of the machine and of the additional equipment must be supplied with dry and oil-free compressed air. The supply pressure must lie between 8 and 10 bar.

7.8.1 Connecting the compressed air maintenance unit

Fig. 62: Connecting the compressed air maintenance unit

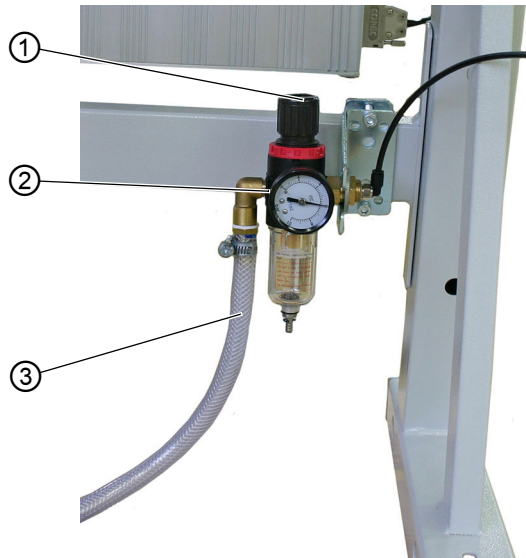

- (1) - Pressure controller
(2) - Pressure gage

- (3) - Connection hose

TO connect the compressed air maintenance unit:



1. Connect the connection hose (3) to the compressed air supply using a hose coupling R 1/4".

7.8.2 Setting operating pressure

NOTICE

Property damage from incorrect setting!

Incorrect operating pressure can result in damage to the machine.

Ensure that the machine is only used when the operating pressure is set correctly.



Proper setting

Refer to the **Technical data** (📖 p. 109) chapter for the permissible operating pressure. The operating pressure cannot deviate by more than ± 0.5 bar.

Fig. 63: Setting operating pressure

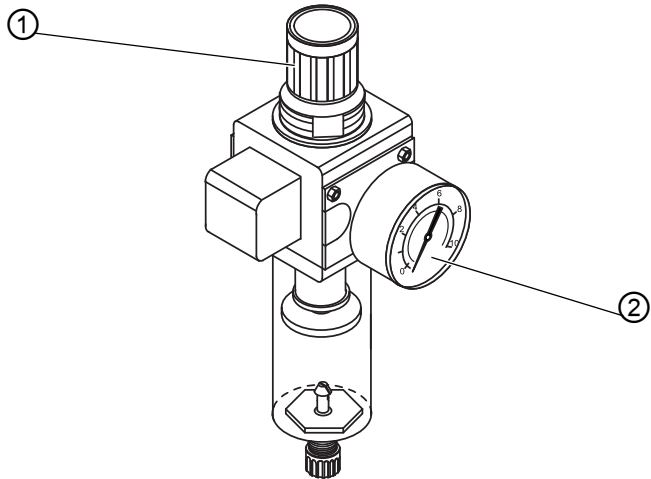

(1) - Pressure controller

(2) - Pressure gage

To set the operating pressure:





1. Pull the pressure controller (1) up.
2. Turn the pressure controller (1) until the pressure gage (2) indicates the desired operating pressure.
 - Increase pressure = turn clockwise
 - Reduce pressure = turn counterclockwise
3. Push the pressure controller (1) down.

7.9 Carrying out a test run

When setup is complete, perform a test run to check the functionality of the machine.

To perform a test run:



1. Insert the power plug.
2. Thread needle thread ( p. 23).
3. Thread looper thread ( p. 25).
4. Switch on the machine.
5. Position the sewing material.
6. Start the sewing process at low speed and then continuously increase the speed.
7. Check that the seams conform to the desired requirements. If they are not, set the thread tension ( p. 31).

8 Decommissioning

You need to perform a number of activities if the machine is to be shut down for a longer period of time or completely decommissioned.

WARNING



Risk of injury from a lack of care!

Serious injuries may occur.

ONLY clean the machine when it is switched off.
Allow ONLY trained personnel to disconnect the machine.

CAUTION



Risk of injuries from contact with oil!

Oil can cause a rash if it comes into contact with skin.

Avoid skin contact with oil.

If oil has come into contact with your skin, wash the affected areas thoroughly.

To decommission the machine:



1. Switch off the machine.
2. Unplug the power plug.
3. If applicable, disconnect the machine from the compressed air supply.
4. Remove residual oil from the oil pan using a cloth.
5. Cover the control panel to protect it from contamination.
6. Cover the controller to protect it from soiling.
7. Cover the entire machine if possible to protect it from contamination and damage.

9 Packing, transportation

The aspects relating to packing and transportation are described below. Keep to the procedure described here to ensure fault-free operation of the machine.

Transport locks

Assemble the transport locks in order to protect the machine from damage during transport, chapter **Setup** ( p. 95).

Packing

WARNING



Risk of injury from cutting parts!

Cutting injuries may be sustained during packing.

Wear safety gloves.

ALWAYS watch out for sharp edges on clamps, paper and packing straps.

WARNING



Risk of injury from moving parts!

Crushing injuries may be sustained during packing.

Wear safety shoes.

Pack the machine so that it cannot slip or fall over. Use a stable base and fasten the machine to this base.

Protect the machine from external damage.

Transport

WARNING



Risk of injury from moving parts!

Crushing injuries may be sustained if the machine is transported improperly.

Ensure the highest possible degree of safety when transporting the machine.

Follow the chapter **Safety** ( p. 9) before transporting the machine.

10 Disposal

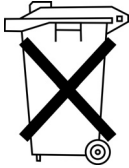

Do not dispose of the machine in the general household waste.

The machine must be disposed of in a suitable manner in accordance with all applicable national regulations.

CAUTION



Risk of environmental damage from improper disposal!

Improper disposal of the machine can result in serious environmental damage.

ALWAYS comply with the national regulations regarding disposal.

When disposing of the machine, be aware that it consists of a range of different materials (steel, plastic, electronic components, etc.). Comply with the national regulations when disposing of these materials.

11 Troubleshooting

11.1 Customer Service

Contact for repairs and issues with the machine:

Dürkopp Adler GmbH

Potsdamer Str. 190
33719 Bielefeld, Germany

Tel. +49 (0) 180 5 383 756

Fax +49 (0) 521 925 2594

Email: service@duerkopp-adler.com

Internet: www.duerkopp-adler.com



11.2 Messages of the software

Please contact customer service if an error occurs that is not described here. Do not attempt to correct the error yourself.

Table of software messages

Code	Type	Possible causes	Remedial action
1000	Error	Sewing motor error: <ul style="list-style-type: none"> • Encoder plug (Sub-D, 9-pin) not connected or defective • Encoder defective 	<ul style="list-style-type: none"> • Check the connection of the encoder cable and replace, if necessary
1001	Error	Sewing motor error: <ul style="list-style-type: none"> • Sewing motor plug not connected or defective 	<ul style="list-style-type: none"> • Check the connection of the sewing motor cable • Test sewing motor phases (R = 2.8Ω, high impedance to PE) • Replace the encoder • Replace the sewing motor • Replace the controller
1002	Error	Sewing motor insulation error	<ul style="list-style-type: none"> • Check motor phase and PE for low-impedance connection • Replace the encoder • Replace the sewing motor
1004	Error	Sewing motor error: <ul style="list-style-type: none"> • Incorrect direction of rotation 	<ul style="list-style-type: none"> • Replace the encoder • Check plug assignment and change, if necessary • Check wiring in machine distributor and change it, if necessary • Test motor phases and check for correct value
1005	Error	Sewing motor current error: <ul style="list-style-type: none"> • Sewing motor blocked • Encoder cable not connected or defective • Encoder defective 	<ul style="list-style-type: none"> • Remove the blockage • Check the encoder cable and replace, if necessary • Replace the sewing motor
1006	Error	Sewing motor error: <ul style="list-style-type: none"> • Max. speed exceeded • Sewing motor cable defective • Sewing motor defective 	<ul style="list-style-type: none"> • Switch the machine off and on again • Replace the encoder • Perform reset • Replace the sewing motor • Contact customer service
1007	Error	Error in the reference run	<ul style="list-style-type: none"> • Replace the encoder • Eliminate stiff movement in the machine

Code	Type	Possible causes	Remedial action
1008	Error	Sewing motor encoder error	<ul style="list-style-type: none"> • Replace the encoder
1010	Error	Sewing motor synchronization error: <ul style="list-style-type: none"> • External synchronizer plug (Sub-D, 9-pin) not connected 	<ul style="list-style-type: none"> • Connect plug of external synchronizer to controller, use correct connection (Sync) • Replace the reference switch or synchronizer • Only required for machines with transmission!
1011	Error	Sewing motor synchronization error (Z pulse)	<ul style="list-style-type: none"> • Switch off the controller, use handwheel to turn and switch on the controller again • If error is not corrected, check encoder
1012	Error	Sewing motor synchronization error	<ul style="list-style-type: none"> • Replace the synchronizer
1051	Error	Sewing motor timeout: <ul style="list-style-type: none"> • Cable to sewing motor • Reference switch defective • Reference switch defective 	<ul style="list-style-type: none"> • Replace the cable • Replace the reference switch
1052	Error	Sewing motor overcurrent: <ul style="list-style-type: none"> • Sewing motor cable defective • Sewing motor defective • Controller defective 	<ul style="list-style-type: none"> • Replace the sewing motor cable • Replace the sewing motor • Replace the controller
1053	Error	Sewing motor overvoltage	<ul style="list-style-type: none"> • Check the mains voltage
1054	Error	Internal short circuit	<ul style="list-style-type: none"> • Replace the controller
1055	Error	Sewing motor overload (I ² T): <ul style="list-style-type: none"> • Sewing motor not moving freely or blocked • Sewing motor defective • Controller defective 	<ul style="list-style-type: none"> • Remove the cause of the stiff movement or blockage • Replace the sewing motor • Replace the controller
1056	Error	Sewing motor overtemperature: <ul style="list-style-type: none"> • Sewing motor not moving freely • Sewing motor defective • Controller defective 	<ul style="list-style-type: none"> • Correct the cause of not moving freely • Replace the sewing motor • Replace the controller
1058	Error	Sewing motor speed greater than setpoint: <ul style="list-style-type: none"> • Reference switch defective • Sewing motor defective 	<ul style="list-style-type: none"> • Replace the reference switch • Replace the sewing motor

Code	Type	Possible causes	Remedial action
1060	Error	PowerParts	<ul style="list-style-type: none"> • Replace the controller
1061	Error	Sewing motor disturbance: <ul style="list-style-type: none"> • Encoder defective • Sewing motor defective 	<ul style="list-style-type: none"> • Switch the machine off and on again • Replace the encoder • Replace the sewing motor • Contact customer service
1062	Error	Sewing motor disturbance (IDMA auto increment)	<ul style="list-style-type: none"> • Switch the machine off and on again
1120	Error	Software error: <ul style="list-style-type: none"> • Parameter not initialized 	<ul style="list-style-type: none"> • Performing a software update
1203	Information	Sewing motor: Position not reached	<ul style="list-style-type: none"> • Switch the machine off and on again • Performing a software update • Contact Customer Service
1302	Error	Sewing motor current error: <ul style="list-style-type: none"> • Sewing motor blocked • Encoder cable not connected or defective • Encoder defective 	<ul style="list-style-type: none"> • Remove the blockage • Check the encoder cable and replace, if necessary • Replace the sewing motor
1330	Error	Sewing motor not responding	<ul style="list-style-type: none"> • Switch the machine off and on again • Performing a software update • Contact Customer Service
2102	Error	X-axis stepper motor: <ul style="list-style-type: none"> • Stepper motor not moving freely or blocked • Encoder cable not connected or defective • Stepper motor cable not connected or defective • Encoder defective • Stepper motor defective 	<ul style="list-style-type: none"> • Remove the cause of the stiff movement or blockage • Check the encoder cable and replace, if necessary • Replace the encoder If the stepper motor is not supplied with current: <ul style="list-style-type: none"> • Check the stepper motor cable and replace, if necessary • Replace the stepper motor
2103	Error	X-axis stepper motor step losses: <ul style="list-style-type: none"> • Stiff mechanical movement or blockage 	<ul style="list-style-type: none"> • Remove the cause of the stiff mechanical movement or blockage

Code	Type	Possible causes	Remedial action
2121	Error	X-axis stepper motor: <ul style="list-style-type: none"> Encoder plug (Sub-D, 9-pin) not connected or defective Encoder defective 	<ul style="list-style-type: none"> Check the connection of the encoder cable and replace, if necessary
2122	Information	Magnet wheel search timeout	<ul style="list-style-type: none"> Check connection cables Check stepper motor for stiff movement
2130	Error	X-axis stepper motor not responding	<ul style="list-style-type: none"> Performing a software update Replace the controller
2152	Error	X-axis stepper motor overcurrent	<ul style="list-style-type: none"> Replace the stepper motor
2153	Error	Excess voltage	<ul style="list-style-type: none"> Check the mains voltage
2155	Error	X-axis stepper motor overload (I^2T): <ul style="list-style-type: none"> Stepper motor not moving freely or blocked Stepper motor defective Controller defective 	<ul style="list-style-type: none"> Remove the blockage or the cause of the stiff movement Replace the stepper motor Replace the controller
2156	Error	X-axis stepper motor: <ul style="list-style-type: none"> Stepper motor not moving freely Stepper motor defective Controller defective 	<ul style="list-style-type: none"> Correct the cause of not moving freely Replace the stepper motor Replace the controller
2162	Error	X-axis stepper motor disturbance (IDMA auto increment)	<ul style="list-style-type: none"> Switch the machine off and on again
2171	Error	Watchdog	<ul style="list-style-type: none"> Switch the machine off and on again Performing a software update Contact Customer Service
2172	Error	Stepper motor overvoltage: <ul style="list-style-type: none"> Stepper motor card defective 	<ul style="list-style-type: none"> Replace the controller
2173	Error	X-axis stepper motor error	<ul style="list-style-type: none"> Check the connection Test stepper motor phases ($R = 2.8\Omega$, high impedance to PE) Replace the encoder Replace the stepper motor Replace the controller

Code	Type	Possible causes	Remedial action
2174	Error	Software error	<ul style="list-style-type: none"> • Perform reset • Performing a software update • Contact Customer Service
2175	Error	Magnet wheel search	<ul style="list-style-type: none"> • Check the connection • Test stepper motor phases (R = 2.8Ω, high impedance to PE) • Replace the encoder • Replace the stepper motor • Replace the controller
2177	Error	Stepper motor overload (I ² T)	<ul style="list-style-type: none"> • Remove the cause of the stiff movement or blockage • Replace the stepper motor • Replace the controller
2178	Error	Encoder error	<ul style="list-style-type: none"> • Check the connection of the encoder cable and replace, if necessary • Replace the controller
2179	Error	Current sensor: <ul style="list-style-type: none"> • Stepper motor card defective • Controller defective 	<ul style="list-style-type: none"> • Replace the controller
2180	Error	Direction of rotation	<ul style="list-style-type: none"> • Replace the encoder • Check plug assignment and change, if necessary • Check wiring in machine distributor and change it, if necessary • Test stepper motor phases and check for correct value
2181	Error	Error in the reference run	<ul style="list-style-type: none"> • Replace the reference switch
2182	Error	Stepper motor current error	<ul style="list-style-type: none"> • Remove the blockage • Check the encoder cable and replace, if necessary • Replace the stepper motor
2183	Error	Stepper motor overcurrent	<ul style="list-style-type: none"> • Replace the sewing motor cable • Replace the stepper motor • Replace the controller
2184	Error	Software error	<ul style="list-style-type: none"> • Perform reset • Performing a software update • Contact Customer Service

Code	Type	Possible causes	Remedial action
2185	Error	Stepper motor insulation error	<ul style="list-style-type: none"> • Check motor phase and PE for low-impedance connection • Replace the encoder • Replace the stepper motor
2186	Error	Software error	<ul style="list-style-type: none"> • Perform reset • Performing a software update • Contact Customer Service
2187	Error	Software error	<ul style="list-style-type: none"> • Perform reset • Performing a software update • Contact Customer Service
2188	Error	Software error	<ul style="list-style-type: none"> • Perform reset • Performing a software update • Contact Customer Service
2202	Error	Y-axis stepper motor: <ul style="list-style-type: none"> • Stepper motor not moving freely or blocked • Encoder cable not connected or defective • Stepper motor cable not connected or defective • Encoder defective • Stepper motor defective 	<ul style="list-style-type: none"> • Remove the cause of the stiff movement or blockage • Check the encoder cable and replace, if necessary • Replace the encoder If the stepper motor is not supplied with current: <ul style="list-style-type: none"> • Check the stepper motor cable and replace, if necessary • Replace the stepper motor
2203	Error	Y-axis stepper motor step losses: <ul style="list-style-type: none"> • Stiff mechanical movement or blockage 	<ul style="list-style-type: none"> • Remove the cause of the stiff mechanical movement or blockage
2221	Error	Y-axis stepper motor: <ul style="list-style-type: none"> • Encoder plug (Sub-D, 9-pin) not connected or defective • Encoder defective 	<ul style="list-style-type: none"> • Check the connection of the encoder cable and replace, if necessary
2222	Information	Magnet wheel search timeout	<ul style="list-style-type: none"> • Check connection cables • Check stepper motor for stiff movement
2230	Error	Y-axis stepper motor not responding	<ul style="list-style-type: none"> • Performing a software update • Replace the controller
2252	Error	Y-axis stepper motor overcurrent	<ul style="list-style-type: none"> • Replace the stepper motor

Code	Type	Possible causes	Remedial action
2253	Error	Excess voltage	<ul style="list-style-type: none"> • Check the mains voltage
2255	Error	Y-axis stepper motor overload (I ² T): <ul style="list-style-type: none"> • Stepper motor not moving freely or blocked • Stepper motor defective • Controller defective 	<ul style="list-style-type: none"> • Remove the blockage or the cause of the stiff movement • Replace the stepper motor • Replace the controller
2256	Error	Y-axis stepper motor: <ul style="list-style-type: none"> • Stepper motor not moving freely • Stepper motor defective • Controller defective 	<ul style="list-style-type: none"> • Correct the cause of not moving freely • Replace the stepper motor • Replace the controller
2262	Error	Y-axis stepper motor disturbance (IDMA auto increment)	<ul style="list-style-type: none"> • Switch the machine off and on again
2271	Error	Watchdog	<ul style="list-style-type: none"> • Switch the machine off and on again • Performing a software update • Contact Customer Service
2272	Error	Stepper motor overvoltage: <ul style="list-style-type: none"> • Stepper motor card defective 	<ul style="list-style-type: none"> • Replace the controller
2273	Error	Y-axis stepper motor error	<ul style="list-style-type: none"> • Check the connection • Test stepper motor phases (R = 2.8Ω, high impedance to PE) • Replace the encoder • Replace the stepper motor • Replace the controller
2274	Error	Software error	<ul style="list-style-type: none"> • Perform reset • Performing a software update • Contact Customer Service
2275	Error	Magnet wheel search	<ul style="list-style-type: none"> • Check the connection • Test stepper motor phases (R = 2.8Ω, high impedance to PE) • Replace the encoder • Replace the stepper motor • Replace the controller

Code	Type	Possible causes	Remedial action
2277	Error	Stepper motor overload (I ² T)	<ul style="list-style-type: none"> • Remove the cause of the stiff movement or blockage • Replace the stepper motor • Replace the controller
2278	Error	Encoder error	<ul style="list-style-type: none"> • Check the connection of the encoder cable and replace, if necessary • Replace the controller
2279	Error	Current sensor: <ul style="list-style-type: none"> • Stepper motor card defective • Controller defective 	<ul style="list-style-type: none"> • Replace the controller
2280	Error	Direction of rotation	<ul style="list-style-type: none"> • Replace the encoder • Check plug assignment and change, if necessary • Check wiring in machine distributor and change it, if necessary • Test stepper motor phases and check for correct value
2281	Error	Error in the reference run	<ul style="list-style-type: none"> • Replace the reference switch
2282	Error	Stepper motor current error	<ul style="list-style-type: none"> • Remove the blockage • Check the encoder cable and replace, if necessary • Replace the stepper motor
2283	Error	Stepper motor overcurrent	<ul style="list-style-type: none"> • Replace the sewing motor cable • Replace the stepper motor • Replace the controller
2284	Error	Software error	<ul style="list-style-type: none"> • Perform reset • Performing a software update • Contact Customer Service
2285	Error	Stepper motor insulation error	<ul style="list-style-type: none"> • Check motor phase and PE for low-impedance connection • Replace the encoder • Replace the stepper motor
2286	Error	Software error	<ul style="list-style-type: none"> • Perform reset • Performing a software update • Contact Customer Service

Code	Type	Possible causes	Remedial action
2287	Error	Software error	<ul style="list-style-type: none"> • Perform reset • Performing a software update • Contact Customer Service
2288	Error	Software error	<ul style="list-style-type: none"> • Perform reset • Performing a software update • Contact Customer Service
2302	Error	Z-axis stepper motor: <ul style="list-style-type: none"> • Stepper motor not moving freely or blocked • Encoder cable not connected or defective • Stepper motor cable not connected or defective • Encoder defective • Stepper motor defective 	<ul style="list-style-type: none"> • Remove the cause of the stiff movement or blockage • Check the encoder cable and replace, if necessary • Replace the encoder If the stepper motor is not supplied with current: <ul style="list-style-type: none"> • Check the stepper motor cable and replace, if necessary • Replace the stepper motor
2303	Error	Z-axis stepper motor step losses: <ul style="list-style-type: none"> • Stiff mechanical movement or blockage 	<ul style="list-style-type: none"> • Remove the cause of the stiff mechanical movement or blockage
2321	Error	Z-axis stepper motor: <ul style="list-style-type: none"> • Encoder plug (Sub-D, 9-pin) not connected or defective • Encoder defective 	<ul style="list-style-type: none"> • Check the connection of the encoder cable and replace, if necessary
2322	Information	Magnet wheel search timeout	<ul style="list-style-type: none"> • Check connection cables • Check stepper motor for stiff movement
2330	Error	Z-axis stepper motor not responding	<ul style="list-style-type: none"> • Performing a software update • Replace the controller
2352	Error	Z-axis stepper motor overcurrent	<ul style="list-style-type: none"> • Replace the stepper motor
2353	Error	Excess voltage	<ul style="list-style-type: none"> • Check the mains voltage
2355	Error	Z-axis stepper motor overload (I^2T): <ul style="list-style-type: none"> • Stepper motor not moving freely or blocked • Stepper motor defective • Controller defective 	<ul style="list-style-type: none"> • Remove the blockage or the cause of the stiff movement • Replace the stepper motor • Replace the controller

Code	Type	Possible causes	Remedial action
2356	Error	Z-axis stepper motor: <ul style="list-style-type: none"> • Stepper motor not moving freely • Stepper motor defective • Controller defective 	<ul style="list-style-type: none"> • Correct the cause of not moving freely • Replace the stepper motor • Replace the controller
2362	Error	Z-axis stepper motor disturbance (IDMA auto increment)	<ul style="list-style-type: none"> • Switch the machine off and on again
2371	Error	Watchdog	<ul style="list-style-type: none"> • Switch the machine off and on again • Performing a software update • Contact Customer Service
2372	Error	Stepper motor overvoltage: <ul style="list-style-type: none"> • Stepper motor card defective 	<ul style="list-style-type: none"> • Replace the controller
2373	Error	Z-axis stepper motor error	<ul style="list-style-type: none"> • Check the connection • Test stepper motor phases (R = 2.8Ω, high impedance to PE) • Replace the encoder • Replace the stepper motor • Replace the controller
2374	Error	Software error	<ul style="list-style-type: none"> • Perform reset • Performing a software update • Contact Customer Service
2375	Error	Magnet wheel search	<ul style="list-style-type: none"> • Check the connection • Test stepper motor phases (R = 2.8Ω, high impedance to PE) • Replace the encoder • Replace the stepper motor • Replace the controller
2377	Error	Stepper motor overload (I ² T)	<ul style="list-style-type: none"> • Remove the cause of the stiff movement or blockage • Replace the stepper motor • Replace the controller
2378	Error	Encoder error	<ul style="list-style-type: none"> • Check the connection of the encoder cable and replace, if necessary • Replace the controller

Code	Type	Possible causes	Remedial action
2379	Error	Current sensor: <ul style="list-style-type: none"> • Stepper motor card defective • Controller defective 	<ul style="list-style-type: none"> • Replace the controller
2380	Error	Direction of rotation	<ul style="list-style-type: none"> • Replace the encoder • Check plug assignment and change, if necessary • Check wiring in machine distributor and change it, if necessary • Test stepper motor phases and check for correct value
2381	Error	Error in the reference run	<ul style="list-style-type: none"> • Replace the reference switch
2382	Error	Stepper motor current error	<ul style="list-style-type: none"> • Remove the blockage • Check the encoder cable and replace, if necessary • Replace the stepper motor
2383	Error	Stepper motor overcurrent	<ul style="list-style-type: none"> • Replace the sewing motor cable • Replace the stepper motor • Replace the controller
2384	Error	Software error	<ul style="list-style-type: none"> • Perform reset • Performing a software update • Contact Customer Service
2385	Error	Stepper motor insulation error	<ul style="list-style-type: none"> • Check motor phase and PE for low-impedance connection • Replace the encoder • Replace the stepper motor
2386	Error	Software error	<ul style="list-style-type: none"> • Perform reset • Performing a software update • Contact Customer Service
2387	Error	Software error	<ul style="list-style-type: none"> • Perform reset • Performing a software update • Contact Customer Service
2388	Error	Software error	<ul style="list-style-type: none"> • Perform reset • Performing a software update • Contact Customer Service

Code	Type	Possible causes	Remedial action
2402	Error	U-axis stepper motor: <ul style="list-style-type: none"> • Stepper motor not moving freely or blocked • Encoder cable not connected or defective • Stepper motor cable not connected or defective • Encoder defective • Stepper motor defective 	<ul style="list-style-type: none"> • Remove the cause of the stiff movement or blockage • Check the encoder cable and replace, if necessary • Replace the encoder If the stepper motor is not supplied with current: <ul style="list-style-type: none"> • Check the stepper motor cable and replace, if necessary • Replace the stepper motor
2403	Error	U-axis stepper motor step losses: <ul style="list-style-type: none"> • Stiff mechanical movement or blockage 	<ul style="list-style-type: none"> • Remove the cause of the stiff mechanical movement or blockage
2421	Error	U-axis stepper motor: <ul style="list-style-type: none"> • Encoder plug (Sub-D, 9-pin) not connected or defective • Encoder defective 	<ul style="list-style-type: none"> • Check the connection of the encoder cable and replace, if necessary
2422	Information	Magnet wheel search timeout	<ul style="list-style-type: none"> • Check connection cables • Check stepper motor for stiff movement
2430	Error	U-axis stepper motor not responding	<ul style="list-style-type: none"> • Performing a software update • Replace the controller
2452	Error	U-axis stepper motor over current	<ul style="list-style-type: none"> • Replace the stepper motor
2453	Error	Excess voltage	<ul style="list-style-type: none"> • Check the mains voltage
2455	Error	U-axis stepper motor overload (I^2T): <ul style="list-style-type: none"> • Stepper motor not moving freely or blocked • Stepper motor defective • Controller defective 	<ul style="list-style-type: none"> • Remove the blockage or the cause of the stiff movement • Replace the stepper motor • Replace the controller
2456	Error	U-axis stepper motor: <ul style="list-style-type: none"> • Stepper motor not moving freely • Stepper motor defective • Controller defective 	<ul style="list-style-type: none"> • Correct the cause of not moving freely • Replace the stepper motor • Replace the controller
2462	Error	<ul style="list-style-type: none"> • U-axis stepper motor disturbance (IDMA auto increment) 	<ul style="list-style-type: none"> • Switch the machine off and on again







Code	Type	Possible causes	Remedial action
2471	Error	<ul style="list-style-type: none"> • Watchdog 	<ul style="list-style-type: none"> • Switch the machine off and on again • Performing a software update • Contact Customer Service
2472	Error	Stepper motor overvoltage: <ul style="list-style-type: none"> • Stepper motor card defective 	<ul style="list-style-type: none"> • Replace the controller
2473	Error	U-axis stepper motor over current error	<ul style="list-style-type: none"> • Check the connection • Test stepper motor phases (R = 2.8Ω, high impedance to PE) • Replace the encoder • Replace the stepper motor • Replace the controller
2474	Error	Software error	<ul style="list-style-type: none"> • Perform reset • Performing a software update • Contact Customer Service
2475	Error	Magnet wheel search	<ul style="list-style-type: none"> • Check the connection • Test stepper motor phases (R = 2.8Ω, high impedance to PE) • Replace the encoder • Replace the stepper motor • Replace the controller
2477	Error	Stepper motor overload (I ² T)	<ul style="list-style-type: none"> • Remove the cause of the stiff movement or blockage • Replace the stepper motor • Replace the controller
2478	Error	Encoder error	<ul style="list-style-type: none"> • Check the connection of the encoder cable and replace, if necessary • Replace the controller
2479	Error	Current sensor: <ul style="list-style-type: none"> • Stepper motor card defective • Controller defective 	<ul style="list-style-type: none"> • Replace the controller

Code	Type	Possible causes	Remedial action
2480	Error	Direction of rotation	<ul style="list-style-type: none"> • Replace the encoder • Check plug assignment and change, if necessary • Check wiring in machine distributor and change it, if necessary • Test stepper motor phases and check for correct value
2481	Error	Error in the reference run	<ul style="list-style-type: none"> • Replace the reference switch
2482	Error	Stepper motor current error	<ul style="list-style-type: none"> • Remove the blockage • Check the encoder cable and replace, if necessary • Replace the stepper motor
2483	Error	Stepper motor overcurrent	<ul style="list-style-type: none"> • Replace the sewing motor cable • Replace the stepper motor • Replace the controller
2484	Error	Software error	<ul style="list-style-type: none"> • Perform reset • Performing a software update • Contact Customer Service
2485	Error	Stepper motor insulation error	<ul style="list-style-type: none"> • Check motor phase and PE for low-impedance connection • Replace the encoder • Replace the stepper motor
2486	Error	Software error	<ul style="list-style-type: none"> • Perform reset • Performing a software update • Contact Customer Service
2487	Error	Software error	<ul style="list-style-type: none"> • Perform reset • Performing a software update • Contact Customer Service
2488	Error	Software error	<ul style="list-style-type: none"> • Perform reset • Performing a software update • Contact Customer Service
2901	Error	Referencing timeout	<ul style="list-style-type: none"> • Switch the machine off and on again • Check the clamping of the stepper motor
3010	Error	Controller: 100 V voltage error	<ul style="list-style-type: none"> • Check the connections • Replace the controller

Code	Type	Possible causes	Remedial action
3011	Error	Controller: 100 V voltage error	<ul style="list-style-type: none"> • Check the connections • Replace the controller
3012	Error	Controller: 100 V voltage error (I ² T)	<ul style="list-style-type: none"> • Switch the machine off and on again • Check the connections • Replace the controller
3020	Error	Short circuit in 24 V input or output	<ul style="list-style-type: none"> • Check the connections • Replace the controller
3021	Error	Short circuit in 24 V input or output	<ul style="list-style-type: none"> • Check the connections • Replace the controller
3022	Error	Short circuit in 24 V input or output (I ² T)	<ul style="list-style-type: none"> • Switch the machine off and on again • Check the connections • Replace the controller
3030	Error	Sewing motor phase error	<ul style="list-style-type: none"> • Test sewing motor phases (R = 2.8Ω, high impedance to PE) • Replace the encoder • Replace the sewing motor • Replace the controller
3104	Warning	<ul style="list-style-type: none"> • Pedal not in rest position • Setpoint device defective 	<ul style="list-style-type: none"> • Do not press the pedal when starting up the machine • Replace the setpoint device
3110	Information	Right thread tension magnet is not connected	<ul style="list-style-type: none"> • Check the connection of the right thread tension magnet
3383	Information	Failure in with the motor referencing process	<ul style="list-style-type: none"> • Check motor • Perform a software update
4440 – 4459	Error	OP3000 control panel: Internal error	<ul style="list-style-type: none"> • Switch the machine off and on again • Performing a software update • Replace the control panel
6000 – 6299	Error	Internal error	<ul style="list-style-type: none"> • Switch the machine off and on again • Performing a software update • Contact Customer Service

Code	Type	Possible causes	Remedial action
6351 – 6354	Error	Controller defective (I ² C)	<ul style="list-style-type: none"> • Replace the controller
6360	Warning	Data on machine ID not admissible	<ul style="list-style-type: none"> • Replace the controller
6361	Warning	Machine ID not connected	<ul style="list-style-type: none"> • Check the connection of the machine ID cable • Replace the machine ID • Replace the controller
6400 – 6999	Error	Internal error	<ul style="list-style-type: none"> • Switch the machine off and on again • Performing a software update • Contact Customer Service
7551 – 7659	Error	<ul style="list-style-type: none"> • Internal error • Cable disturbance • Cables to the control panel Interface defective 	<ul style="list-style-type: none"> • Switch the machine off and on again • Eliminate source of disturbance • Performing a software update • Replace the cable • Contact customer service
9310	Error	<ul style="list-style-type: none"> • CAN connector not plugged in or faulty • Tape unwinder faulty 	<ul style="list-style-type: none"> • Replace the CAN connector • Replace the tape unwinder • Replace the controller
9320	Error	<ul style="list-style-type: none"> • Tape unwinder dirty • Tape unwinder faulty 	<ul style="list-style-type: none"> • Clean the tape unwinder (📖 p. 84) • Open the throttle • Replace the tape unwinder
9910	Error	Tilt sensor: <ul style="list-style-type: none"> • Machine head is tilted over • Tilt sensor not assembled or defective 	<ul style="list-style-type: none"> • Erecting the machine head • Fit or replace tilt sensor

11.3 Errors in sewing process

Meaning	Possible causes	Remedial action
Thread breakage	<ul style="list-style-type: none"> The needle and looper threads are not threaded correctly 	<ul style="list-style-type: none"> Check the thread path ( p. 19)
	<ul style="list-style-type: none"> Needle is bent or sharp-edged Needle is not inserted correctly into the needle bar 	<ul style="list-style-type: none"> Replace the needle Insert the needle into the needle bar
	<ul style="list-style-type: none"> The thread used is unsuitable 	<ul style="list-style-type: none"> Use recommended thread
	<ul style="list-style-type: none"> Thread tensions are too tight for the thread used 	<ul style="list-style-type: none"> Check thread tensions ( p. 31)
	<ul style="list-style-type: none"> Thread-guiding parts such as thread tube, thread guide or thread-takeup disk are sharp-edged 	<ul style="list-style-type: none"> Check the thread path
	<ul style="list-style-type: none"> Throat plate, looper or spread have been damaged by the needle 	<ul style="list-style-type: none"> Have parts reworked by qualified specialists
Missing stitches	<ul style="list-style-type: none"> The needle and looper threads are not threaded correctly 	<ul style="list-style-type: none"> Check the thread path ( p. 19)
	<ul style="list-style-type: none"> Needle is blunt or bent Needle is not inserted correctly into the needle bar 	<ul style="list-style-type: none"> Replace the needle Insert the needle into the needle bar
	<ul style="list-style-type: none"> The needle thickness used is unsuitable 	<ul style="list-style-type: none"> Use recommended needle thickness ( p. 135)
	<ul style="list-style-type: none"> The thread reel holder is installed incorrectly 	<ul style="list-style-type: none"> Check thread reel holder ( p. 98)
	<ul style="list-style-type: none"> Thread tensions are too tight 	<ul style="list-style-type: none"> Check thread tensions ( p. 31)
	<ul style="list-style-type: none"> Sewing material is not held correctly 	<ul style="list-style-type: none"> Check clamping pressure
	<ul style="list-style-type: none"> The loop stroke was not corrected when changing the zigzag stitch width 	<ul style="list-style-type: none"> Set the loop stroke
	<ul style="list-style-type: none"> Incorrect parts used for the desired sewing equipment 	<ul style="list-style-type: none"> Check the parts based on the equipment sheet
	<ul style="list-style-type: none"> Throat plate, looper or spread have been damaged by the needle 	<ul style="list-style-type: none"> Have parts reworked by qualified specialists

Meaning	Possible causes	Remedial action
Loose stitches	• Thread tensions are not adjusted to the sewing material, the sewing material thickness or the thread used	• Check thread tensions (📖 p. 31)
	• The needle and looper threads are not threaded correctly	• Check the thread path (📖 p. 19)
Needle breakage	• Needle thickness is unsuitable for the sewing material or the thread	• Use recommended needle
Seam beginning not secure	• Residual tension is too tight for the needle thread	• Adjust residual tension

12 Technical data

Noise emission

Workplace-specific emission value as per DIN EN ISO 10821:

$L_{pA} = 78 \text{ dB (a)} \pm 1.48 \text{ dB (A)}$ at

- Stitch length: 3 mm
- Sewing foot stroke: 0 mm
- Speed: 3000 min^{-1}
- Sewing material: 2-layer material G1 DIN 23328

Data and parameters

Technical data	Unit	610-10	630-10
Machine type		Engineered workstation	
Stitch type		Double chain stitch 401	
Looper type		Crossline	
Number of needles		1	
Needle system		934 RG	
Needle thickness	[Nm]	70 – 130	
Thread strength	[Nm]	bis 70/3	
Stitch length	[mm]	1.0 – 4.0	
Speed maximum	$[\text{min}^{-1}]$	5000	
Speed on delivery	$[\text{min}^{-1}]$	3200	
Feed length maximum for diff. feed dog	[mm]	6	
Feed length maximum for feeding foot	[mm]	8	
Needle bar stroke	[mm]	32	
Sewing foot stroke	[mm]	9	

Technical data	Unit	610-10	630-10
Mains voltage	[V]	230	
Mains frequency	[Hz]	50	
Operating pressure	[bar]	6	
Air consumption [per cycle]	[NL]	0.1	
Length	[mm]	1350	1350
Width	[mm]	900	900
Height	[mm]	1250	1100
Weight	[kg]	109	103
Rated power: - StandBy - Operation	[kW]	< 0.05 0.5	
Power input	[kVA]	1.0	

Fig. 65: Dimensions for manufacturing a table top (2)

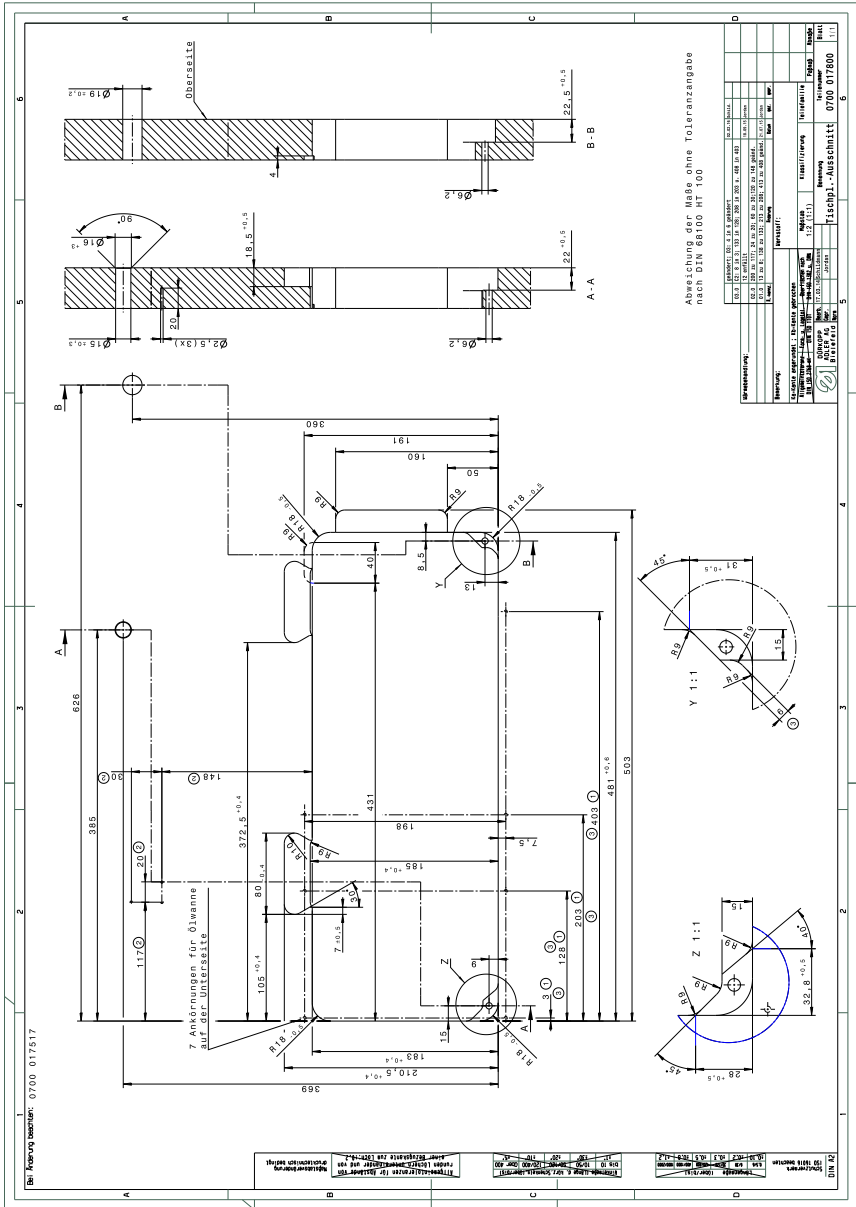

Fig. 66: Wiring diagram (1)

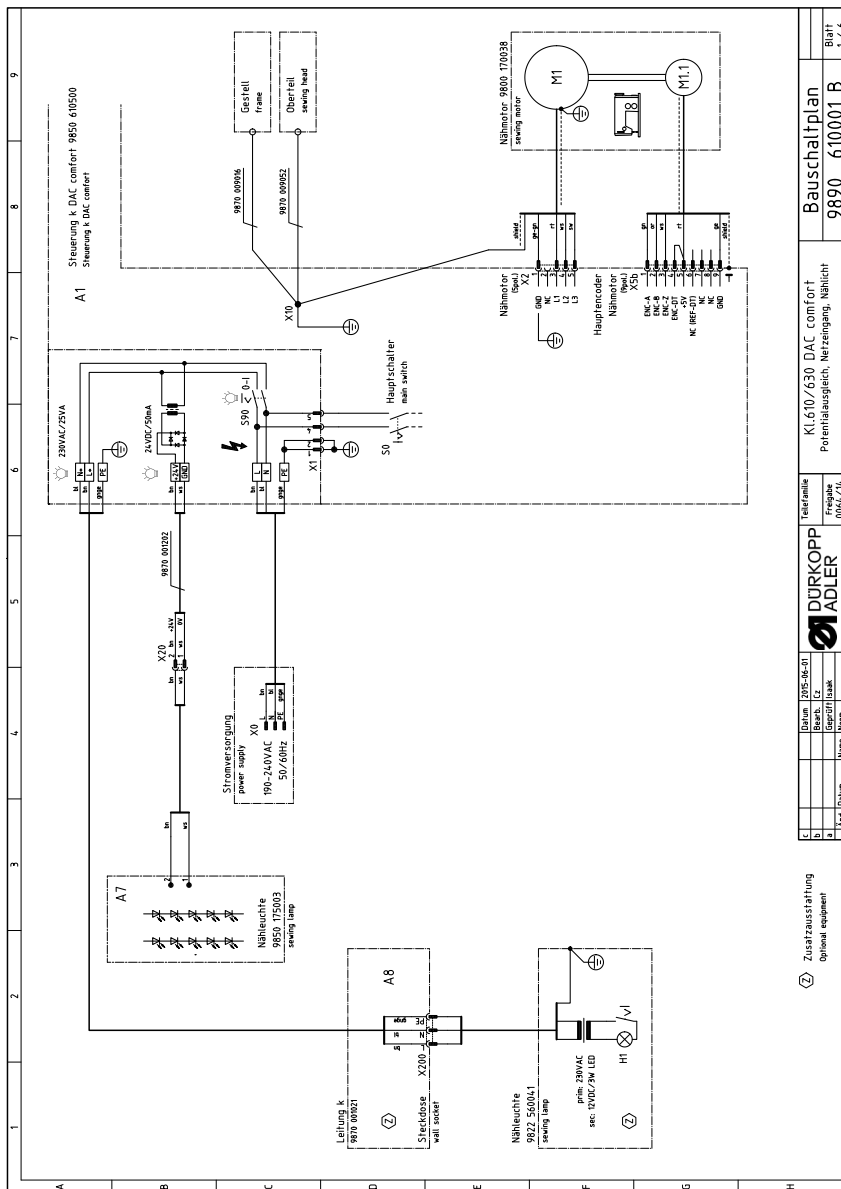
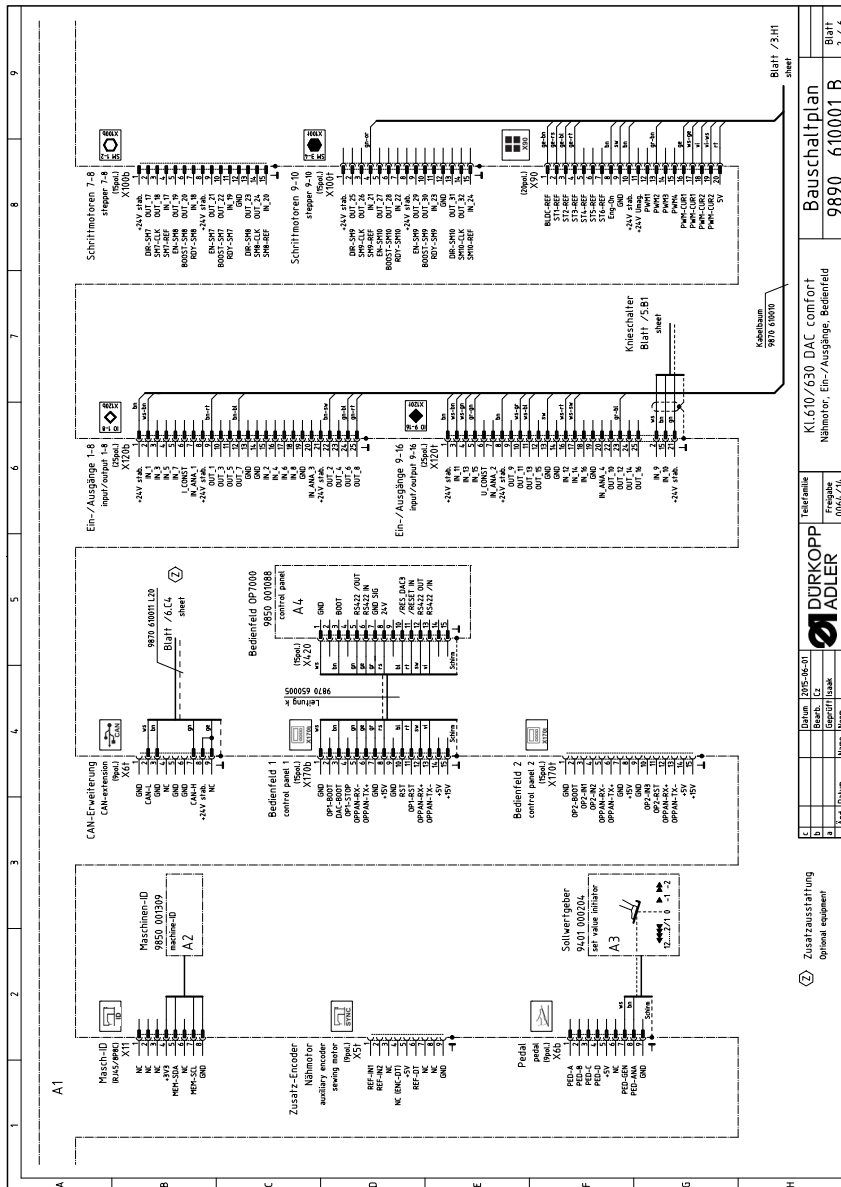
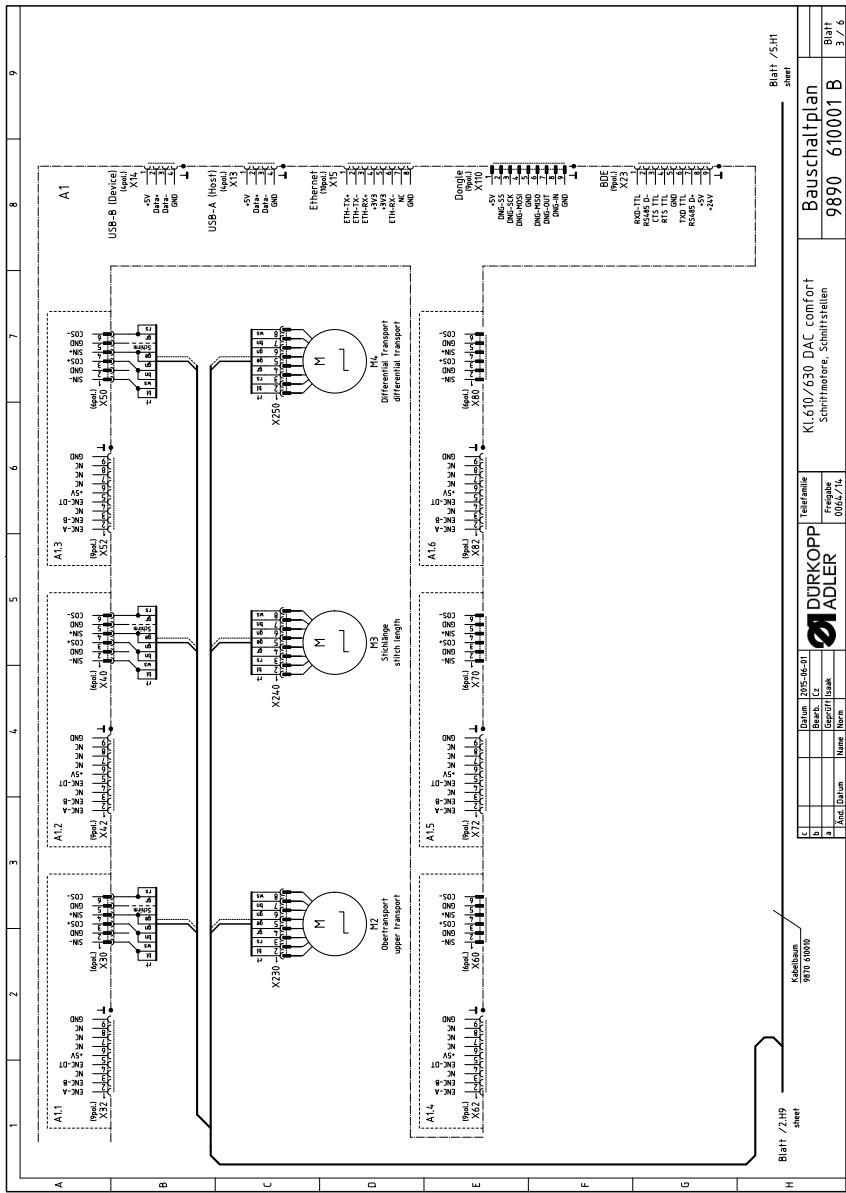

Fig. 67: Wiring diagram (2)



Datei		2015-06-01	Zustausstattung Optional equipment	
Berech.		Lz	Licenziert/Isak	
Name		Isak	Name	
Last Datum			Name	
Testranke		9890	DURKOPP ADLER	
Prozess		0046474	KI 630/630 DAC comfort	
Kabelbaum		9890 61001	Näsmotor, Ein-/Ausgangs-Beaufschlagung	
Bauschaltplan		9890 61001 B	Blatt / 3/11	
Blatt		2, 2 &	Blatt	

Fig. 68: Wiring diagram (3)



Date: 2015-06-01		Test range: KL 510/630 DAC comfort		Blatt / 5.H1 sheet	
Drawn: [Name]		Schrittmotor, Schrittbauten		Blatt 3.2 & B	
Checked: [Name]		DÜRKOPP ADLER		Bauschaltplan 9890 610001 B	
Approved: [Name]		0046/74			
Task	Date	Name	Task	Date	Name

Fig. 71: Wiring diagram (6)

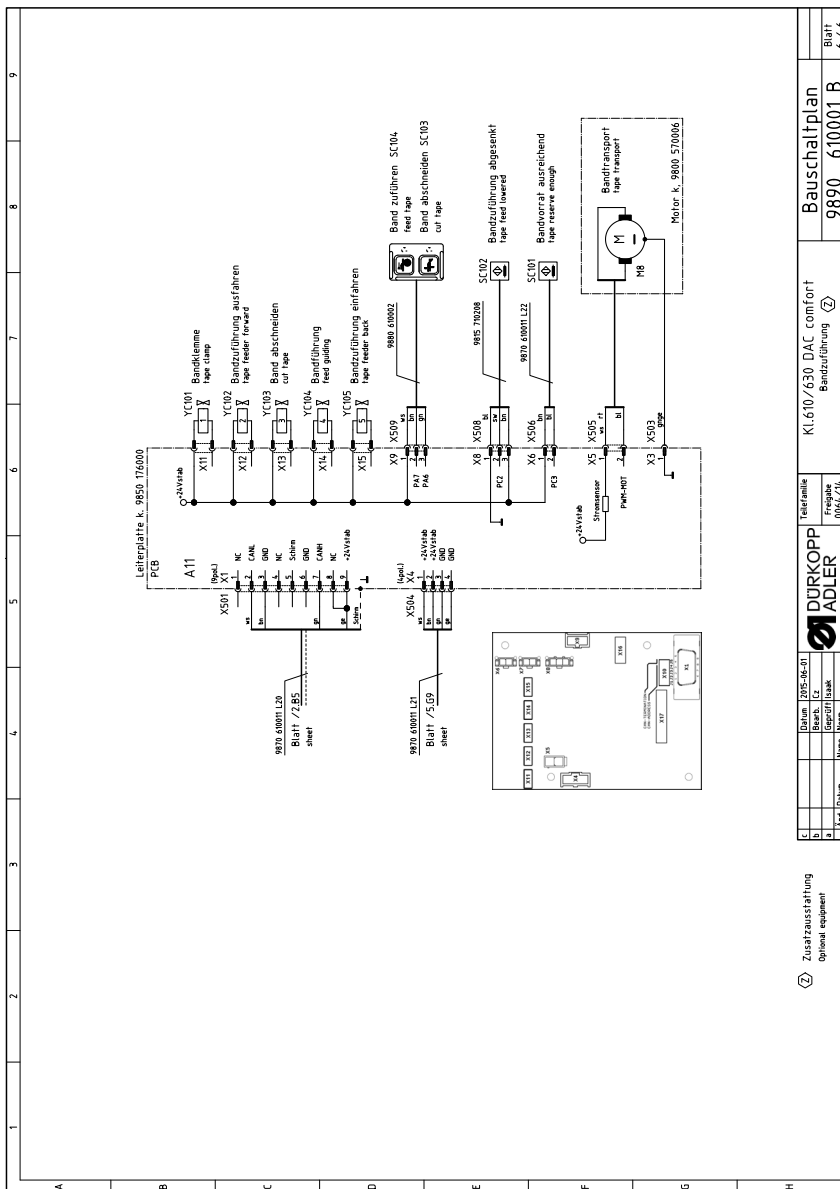

⊕ Züstausstattung
Optional equipment

c	Datum	2025-06-01
b	Bereit. Nr	
a	Gezeichnet / isak	
	Name	isak
	Check	Datum

DÜRKOPP ADLER	
Testramme	0046474
KL 610/630 DAC comfort	
Bandzuführung ⊕	

Bauschaltplan	9890 610001 B
Blatt	3, 2 & 8

DÜRKOPP ADLER GmbH

Potsdamer Straße190

33719 Bielefeld

GERMANY

Phone +49(0)521/925-00

E-mail service@duerkopp-adler.com

www.duerkopp-adler.com

